

# Listwa T530 – montaż wariant 1

1.

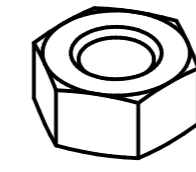

Nakrętka M8 DIN 934

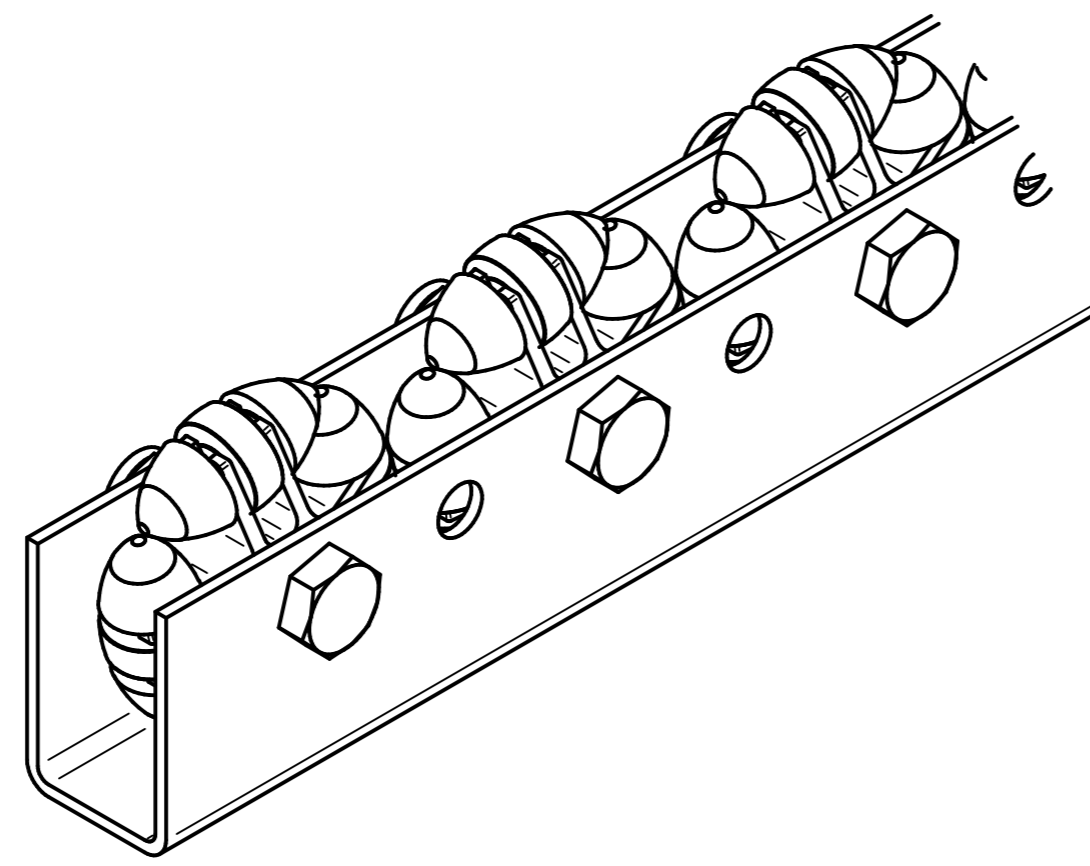
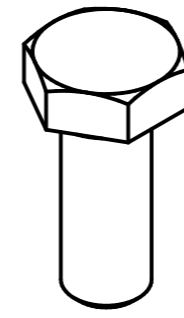

Listwa T530

Śruba DIN 933 M8

2.

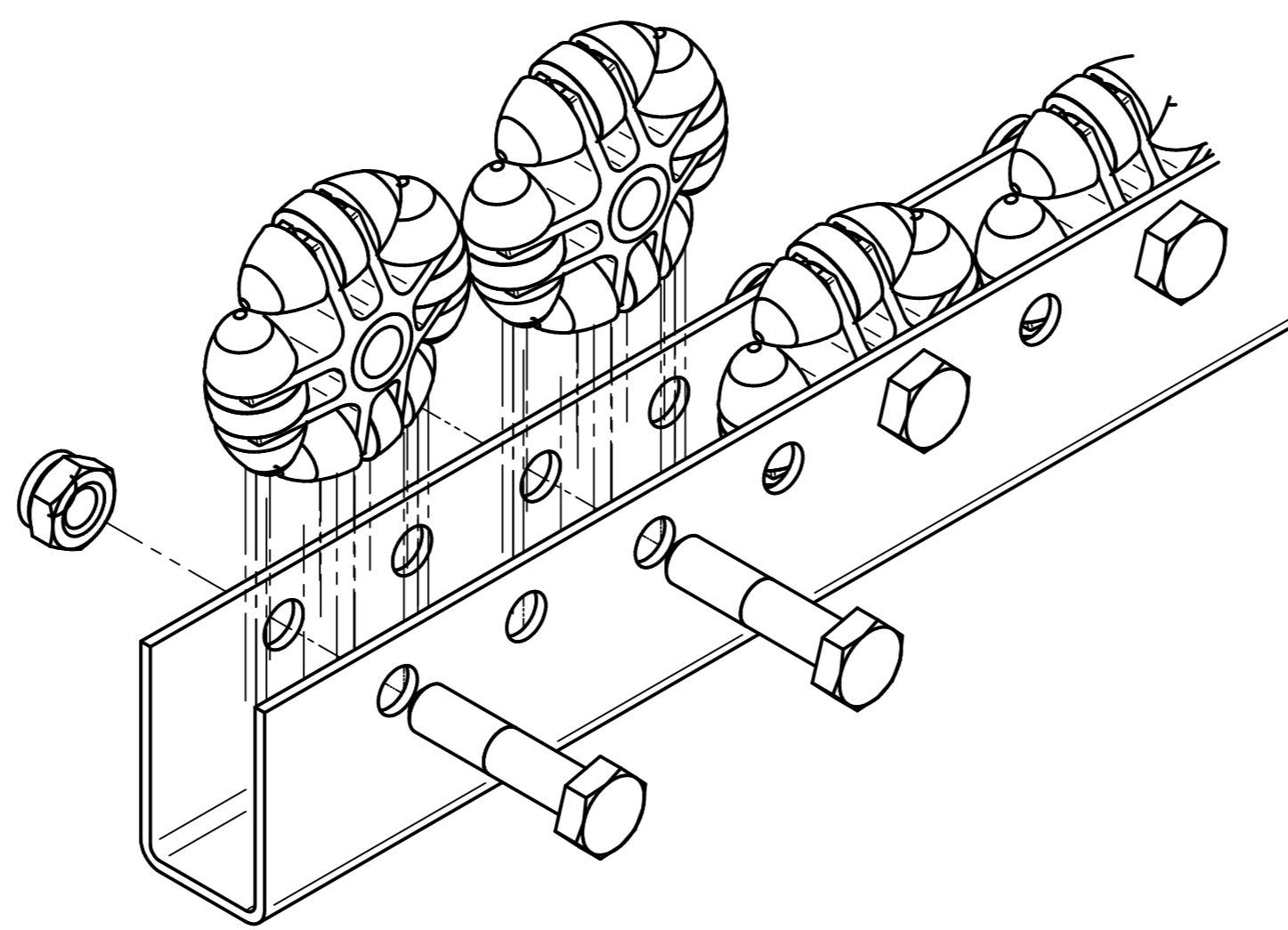

3.

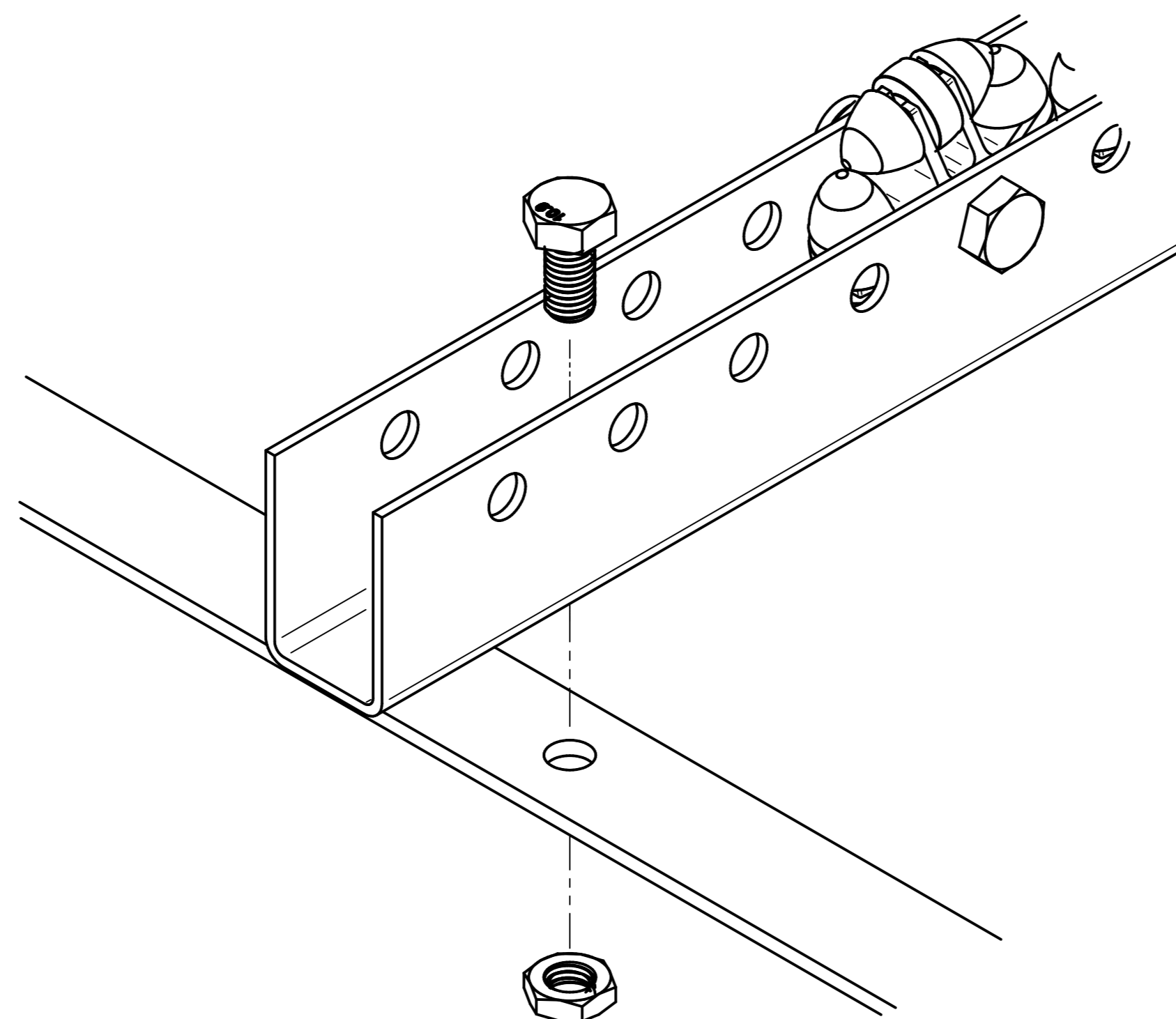

4.

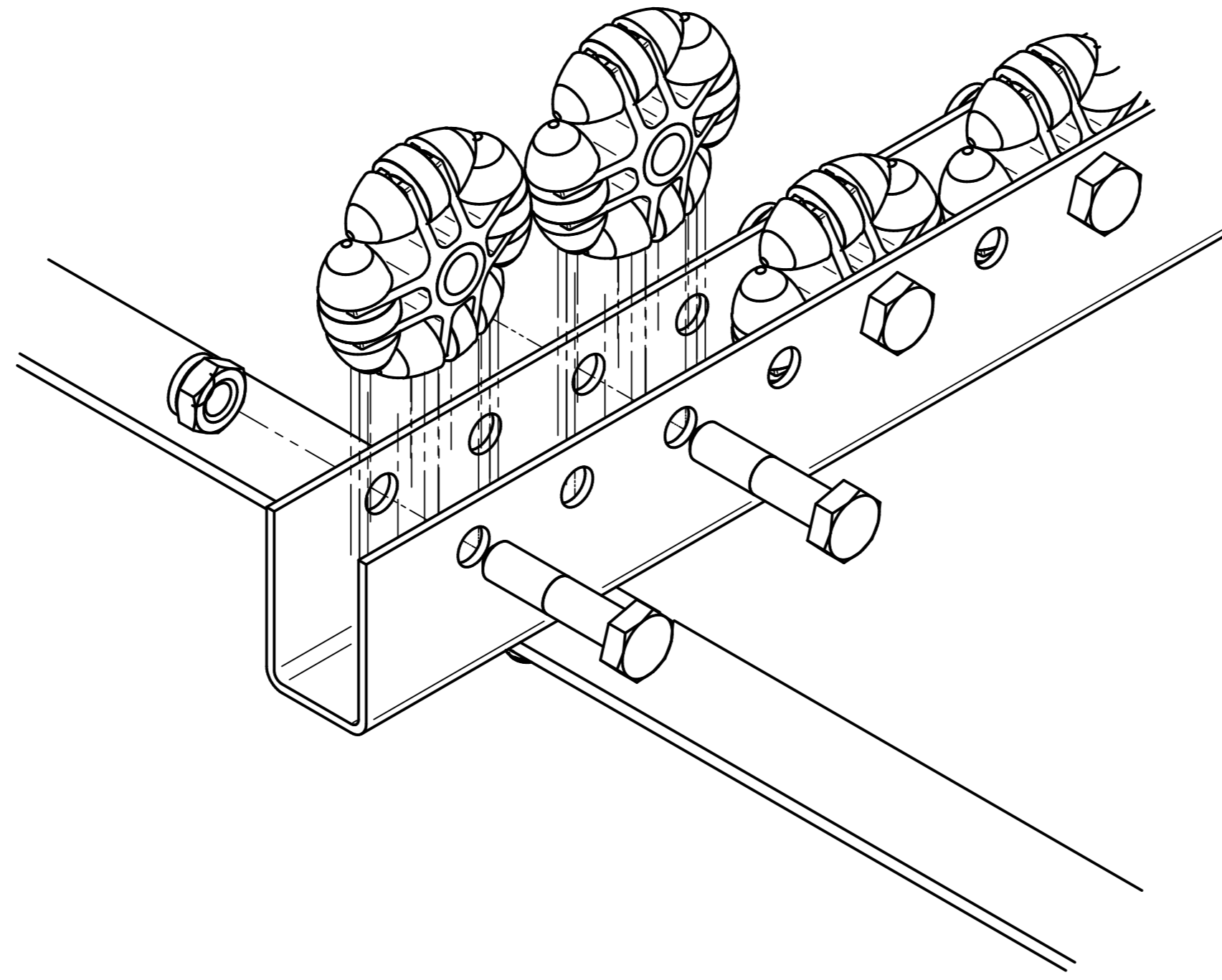

5.

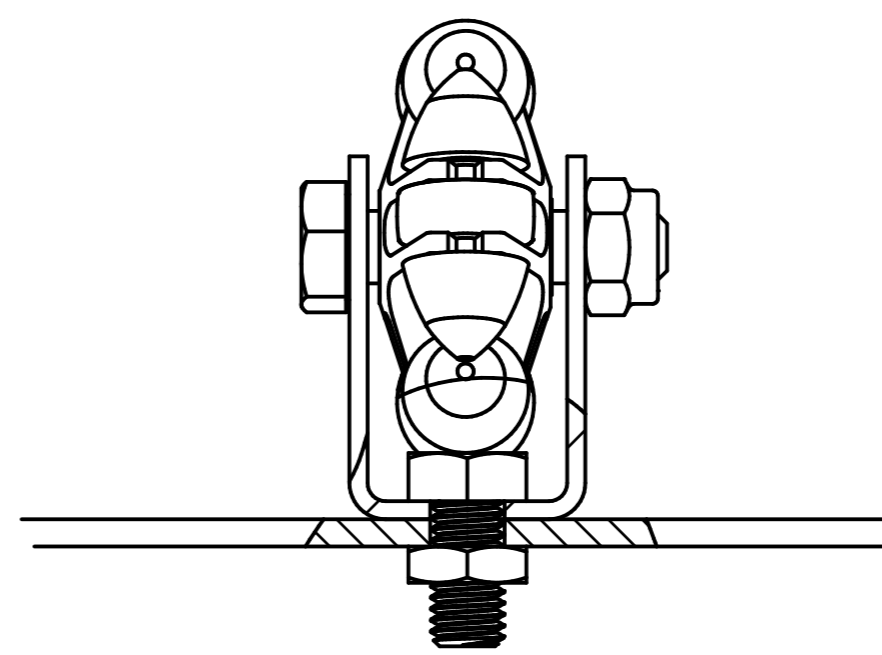
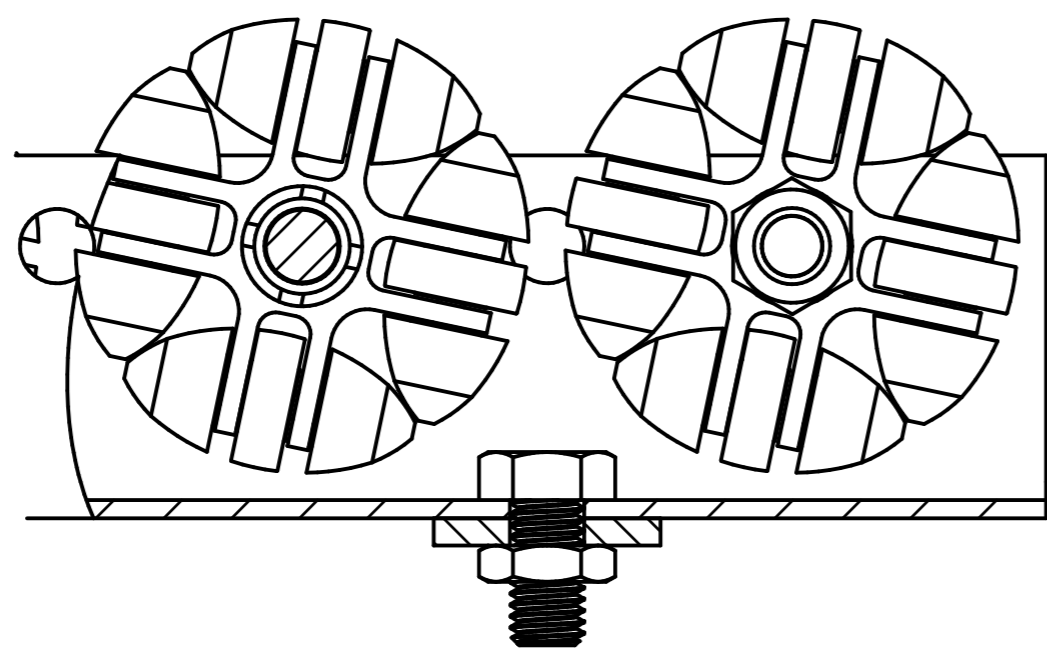
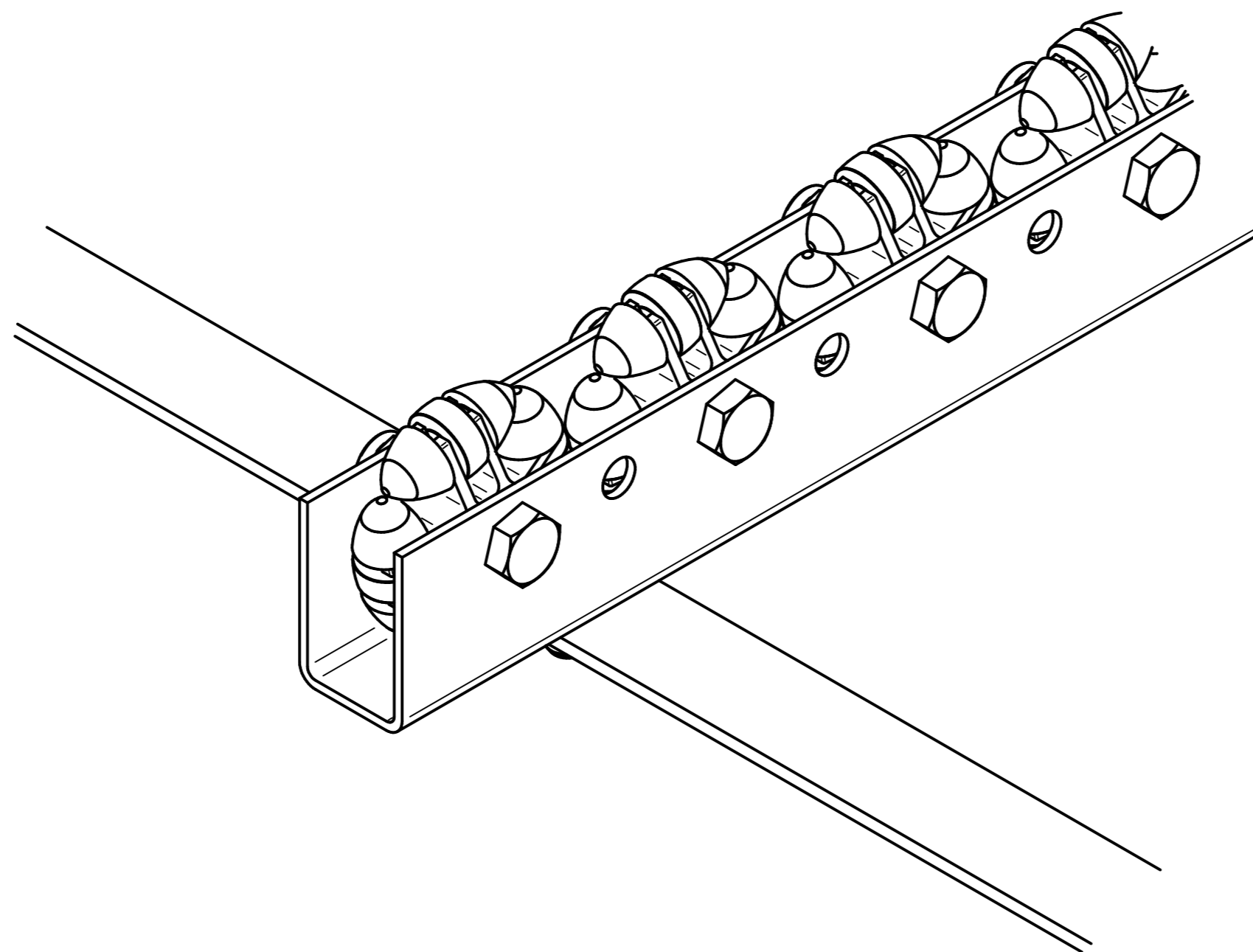

# Listwa T530 – montaż wariant 2

1.

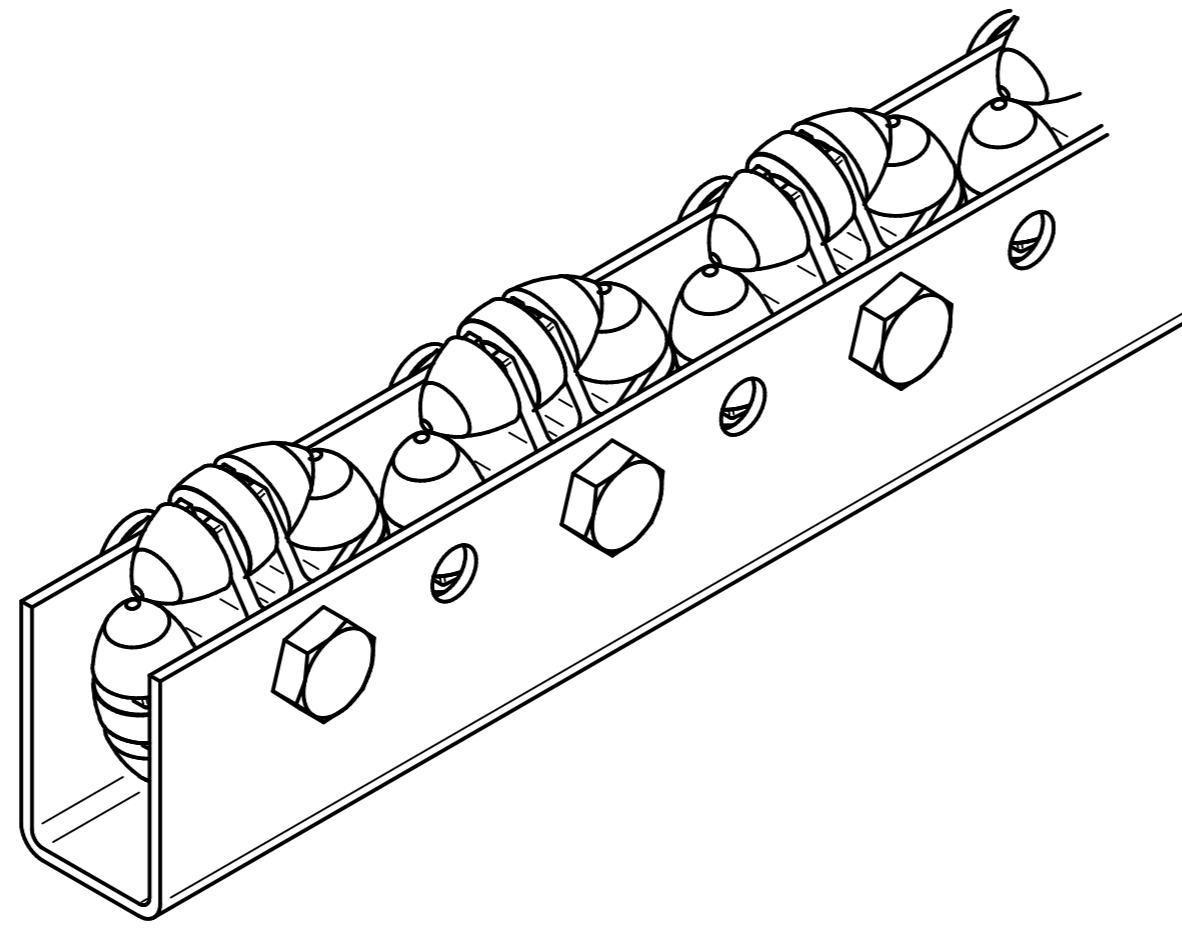

Listwa T530

2.

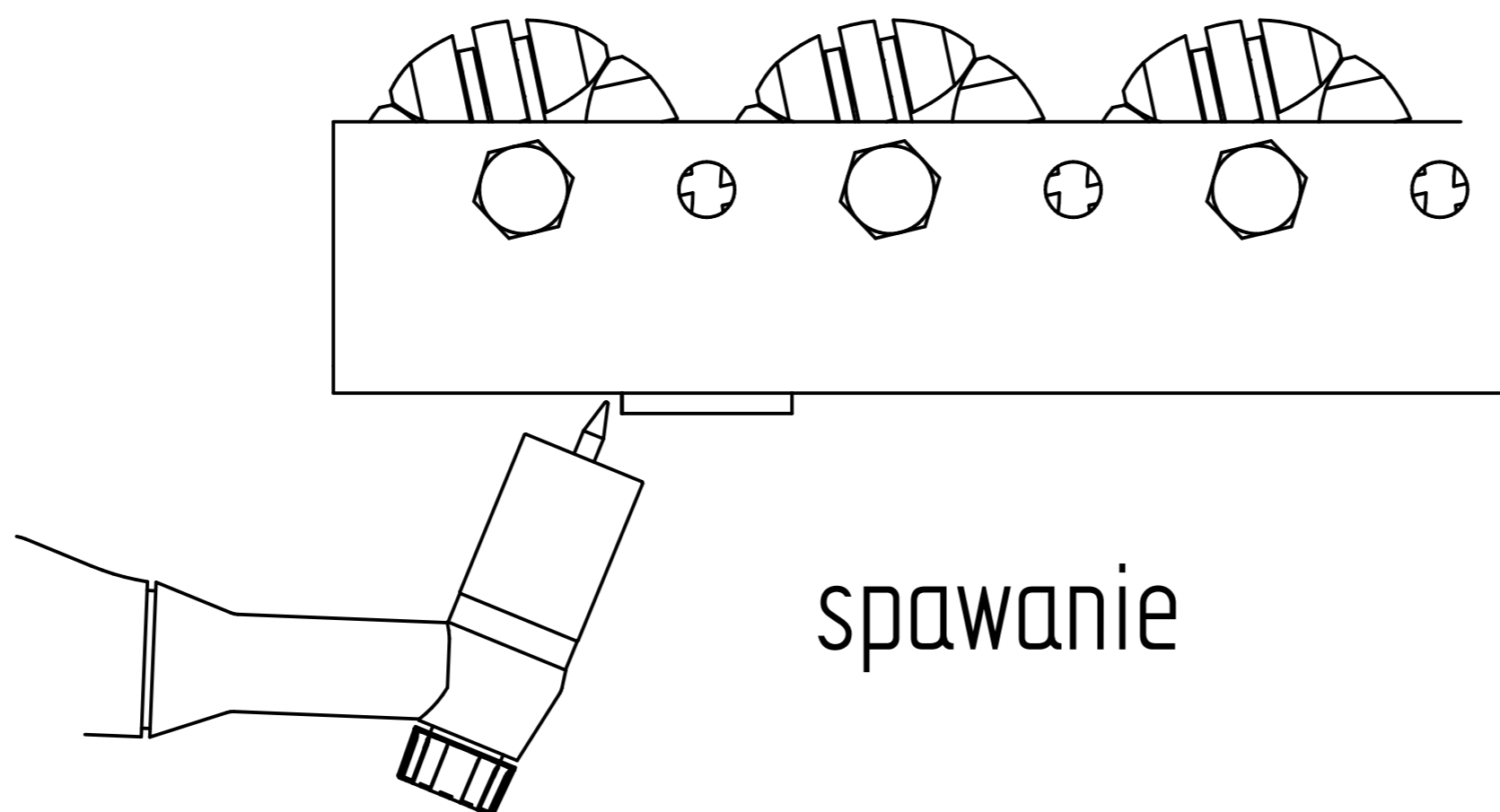

Rolki należy schłodzić bezpośrednio po spawaniu