

# Listwa T500 – montaż wariant 1

1.

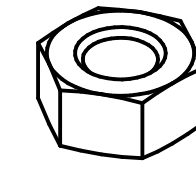

Nakrętka M8 DIN 934

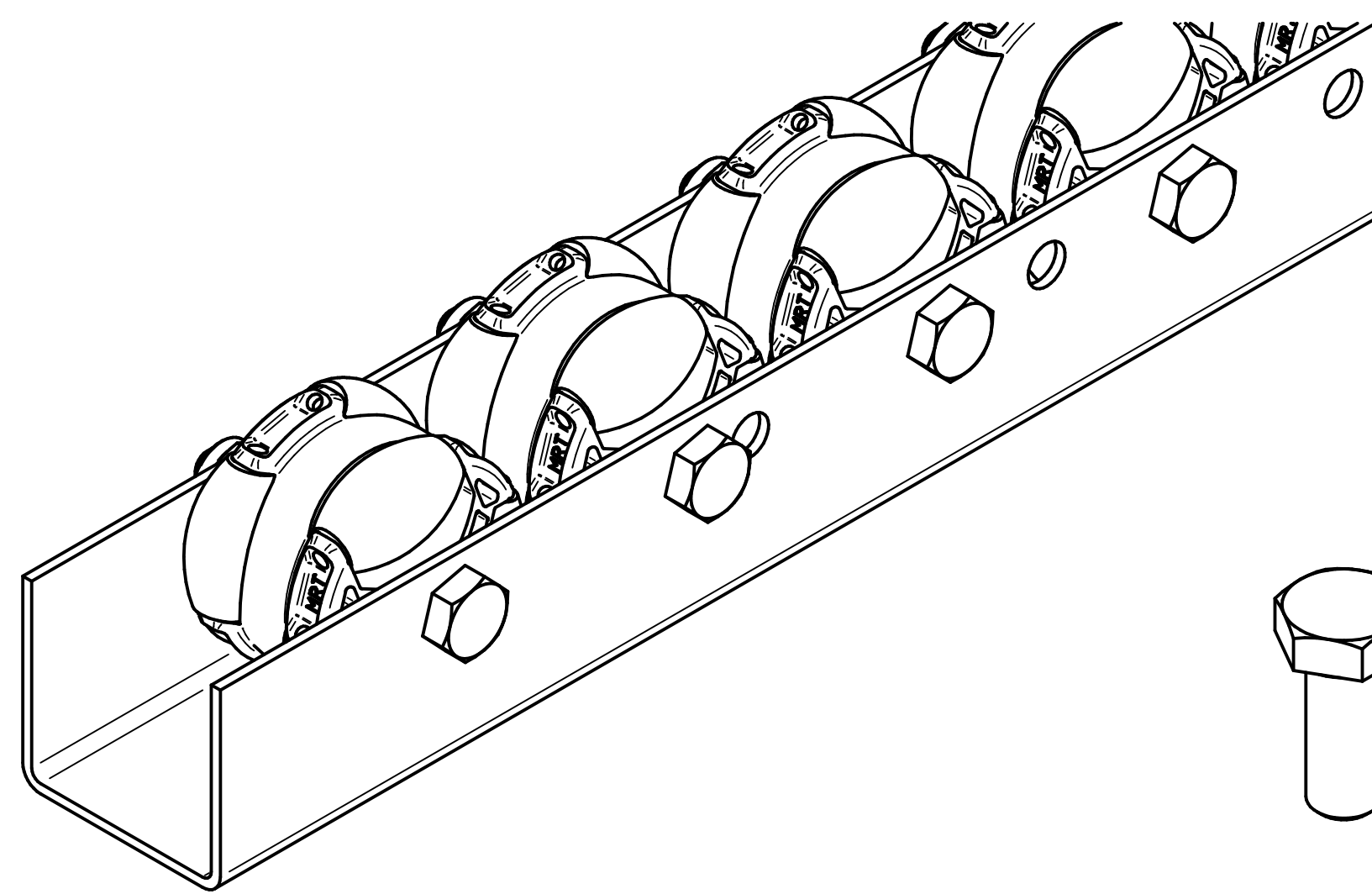
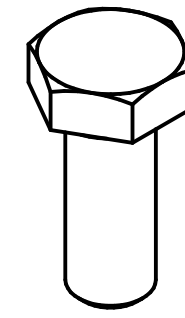

Listwa T500

Śruba DIN 933 M8

2.

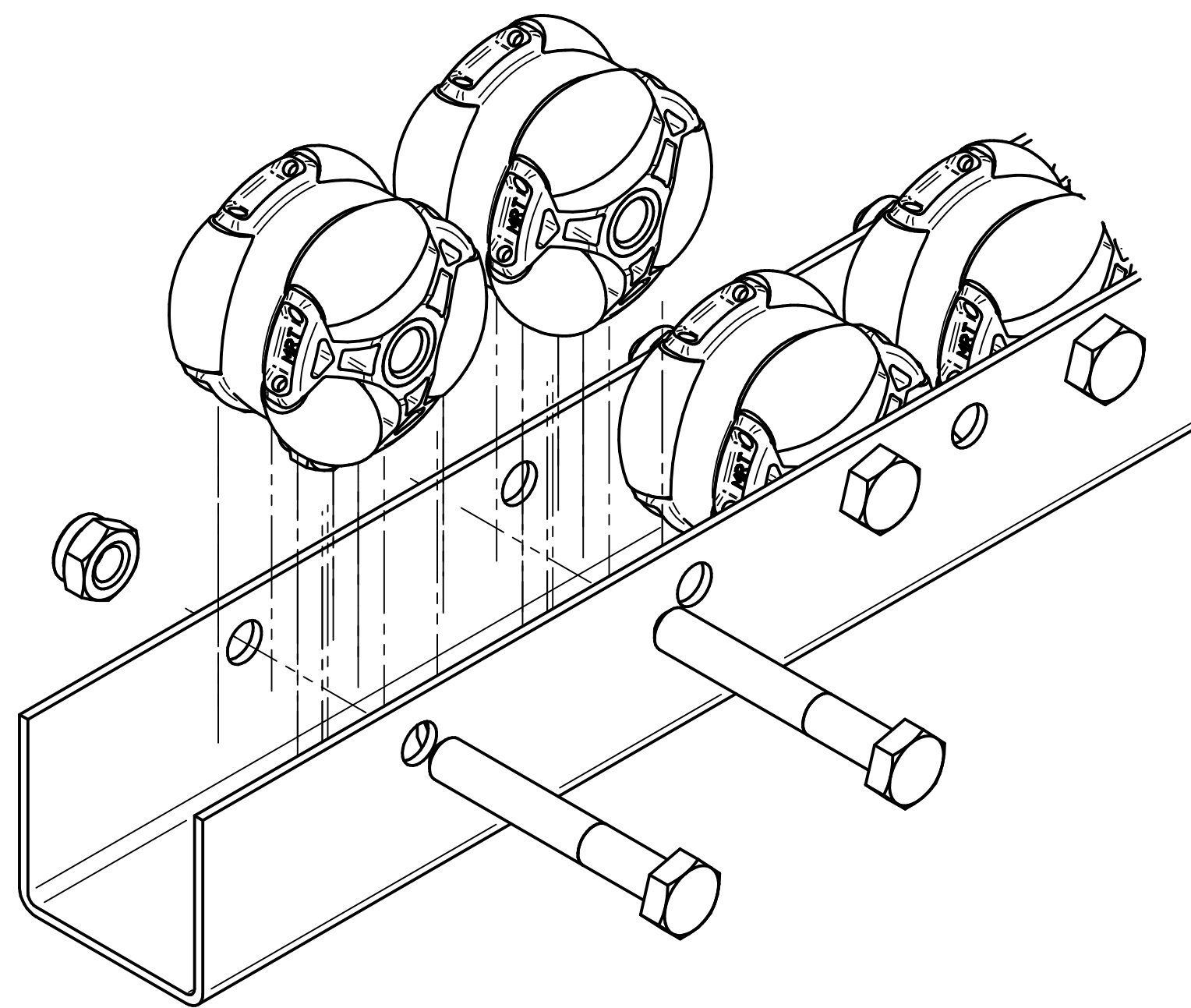

3.

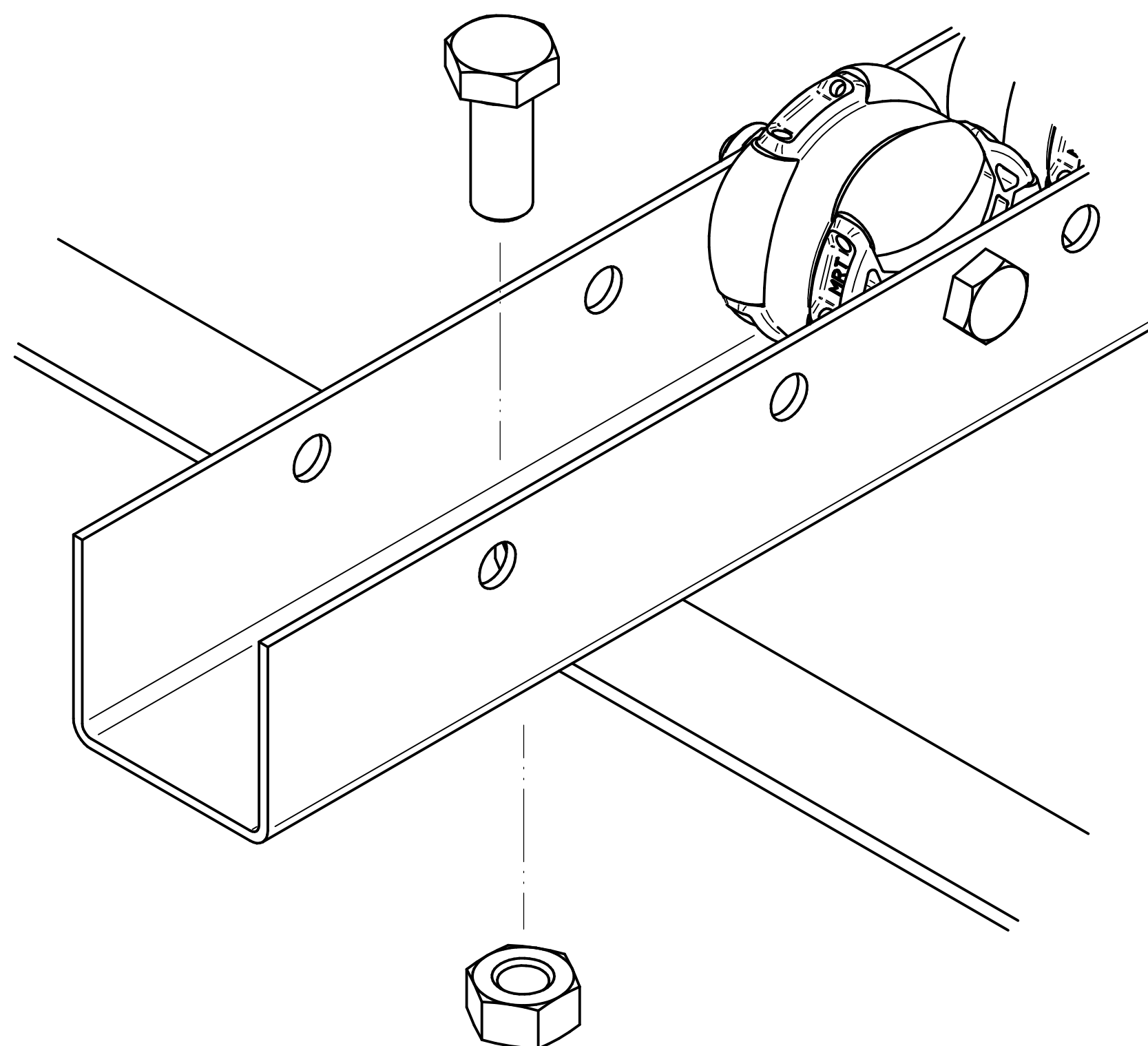

4.

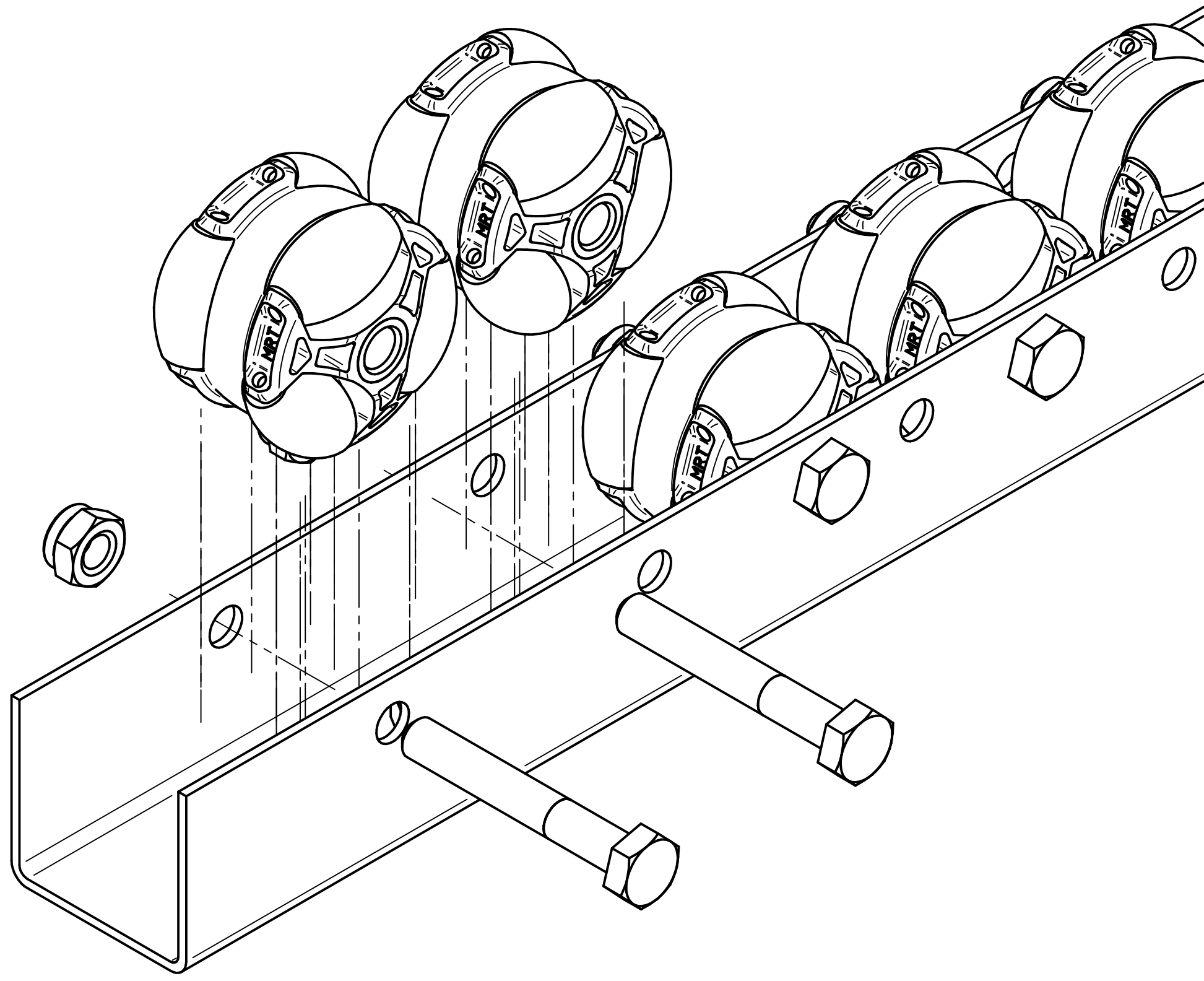

5.

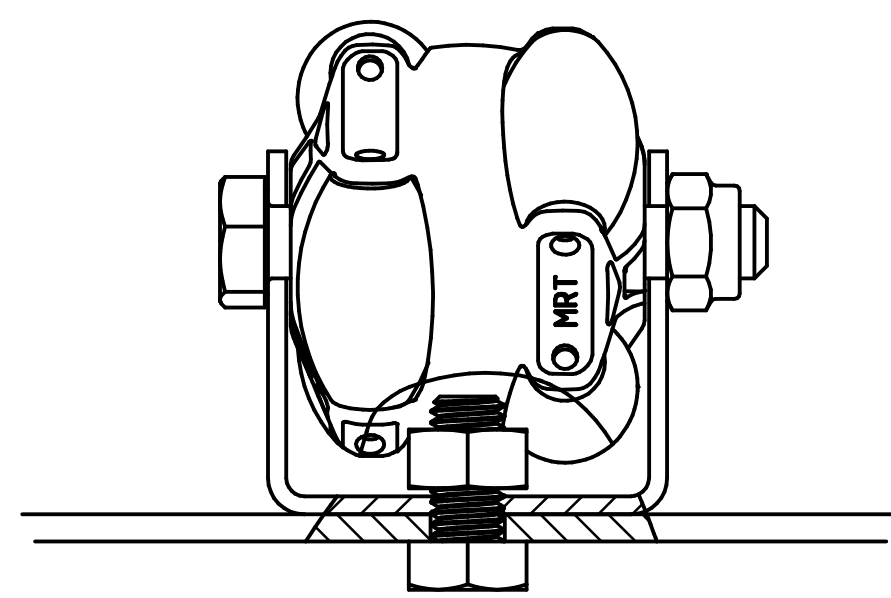
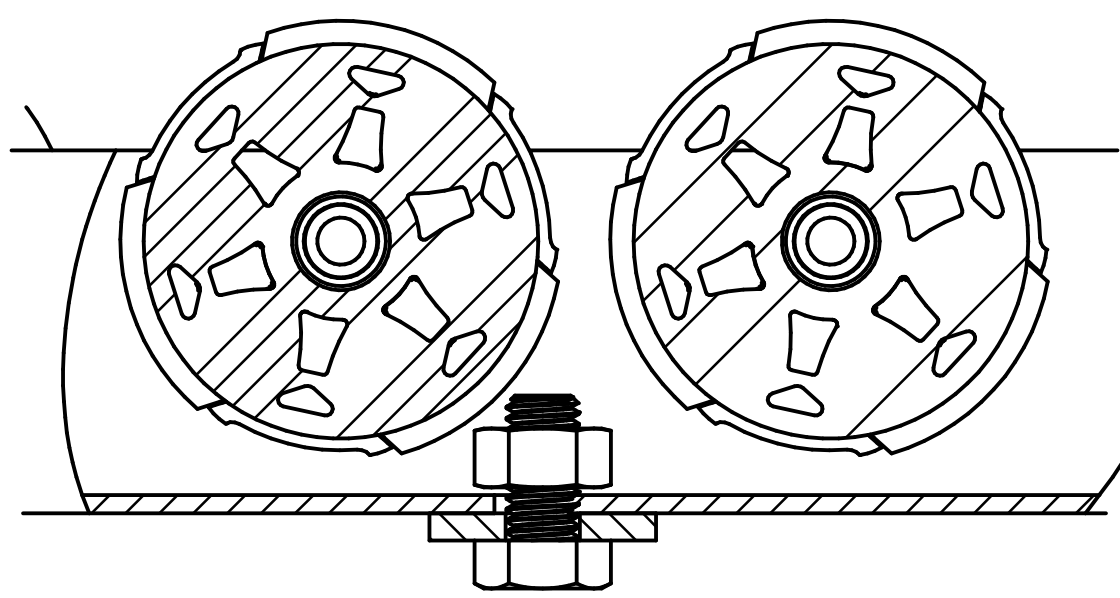
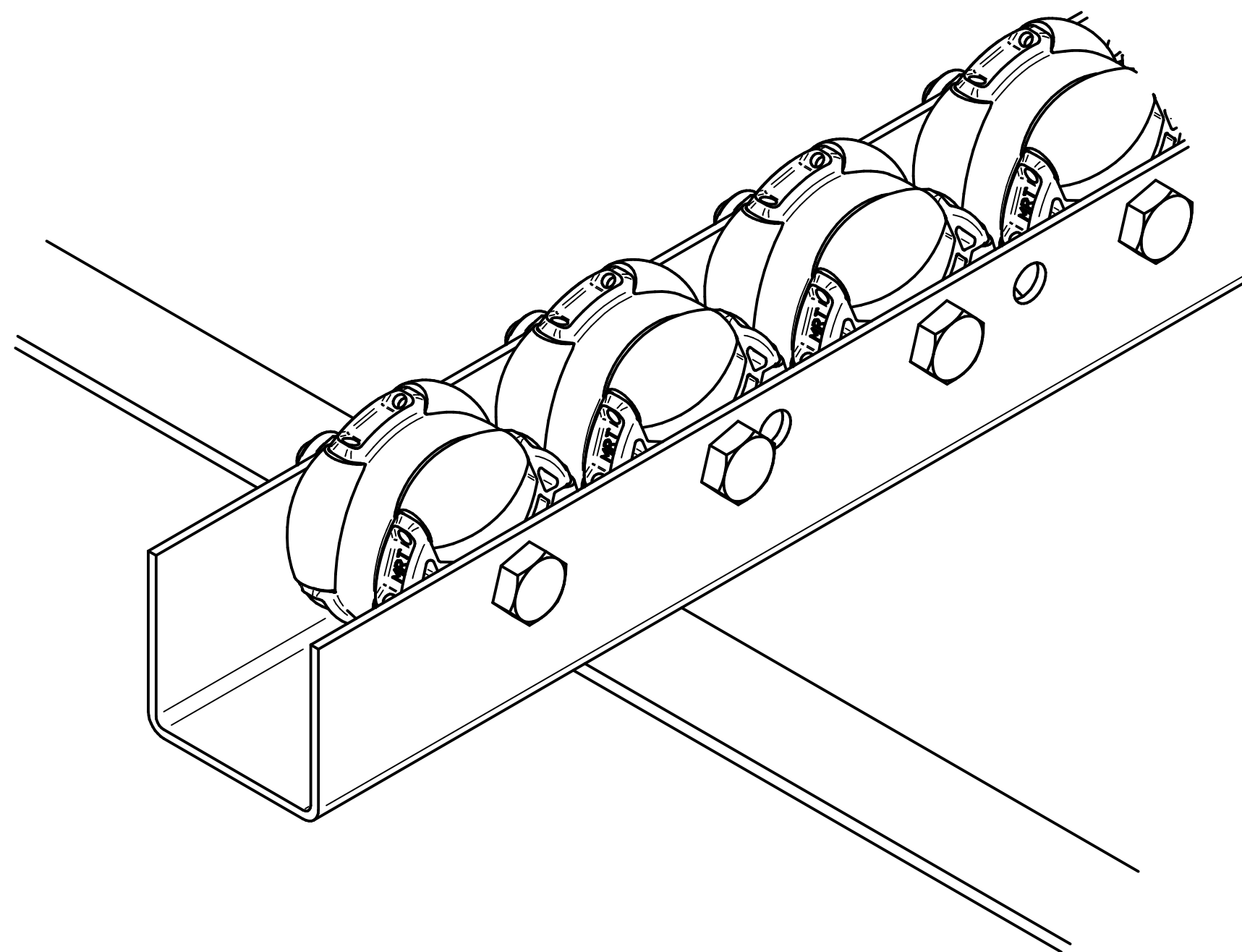

# Listwa T500 – montaż wariant 2

1.

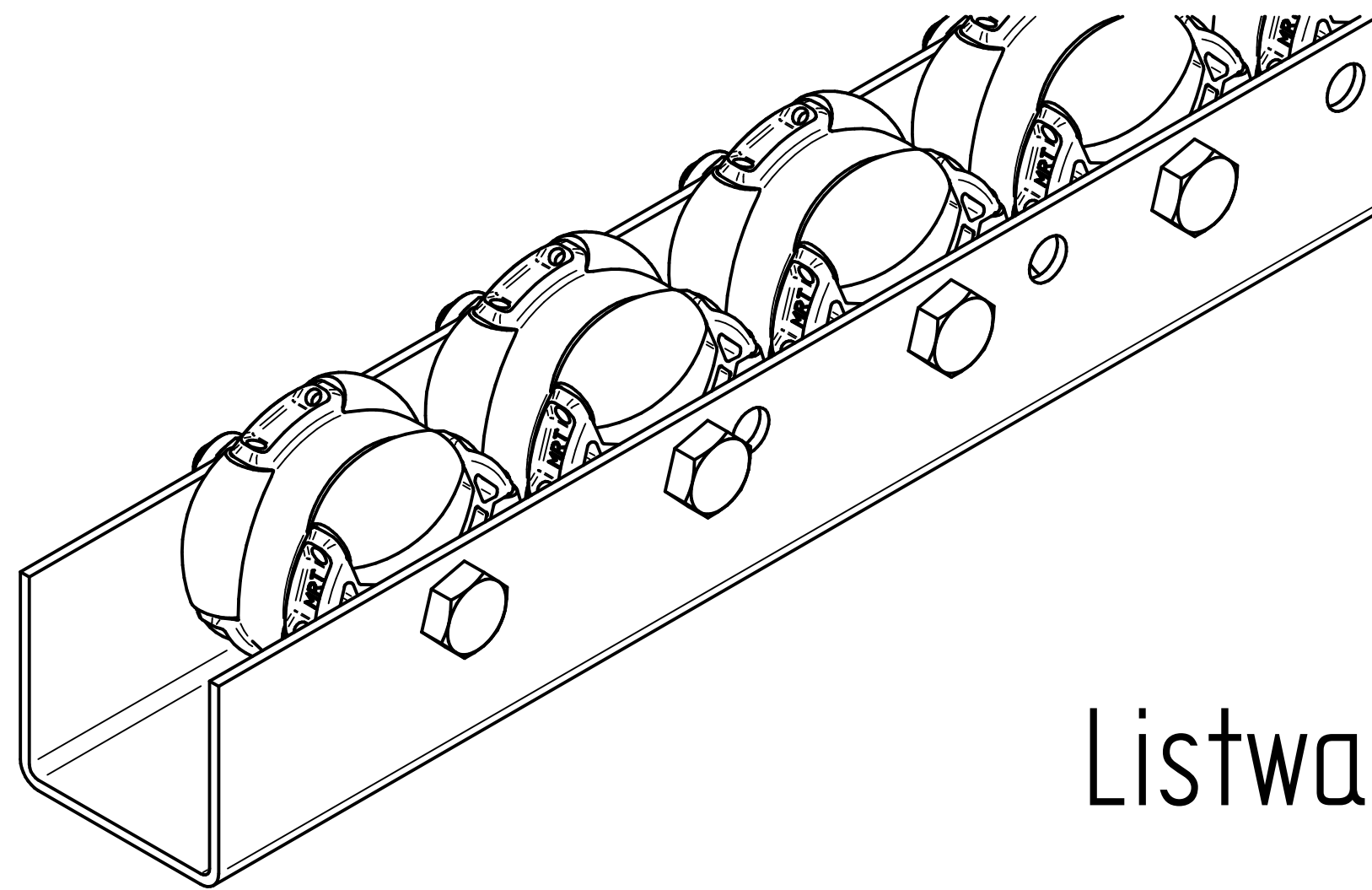

Listwa T500

2.

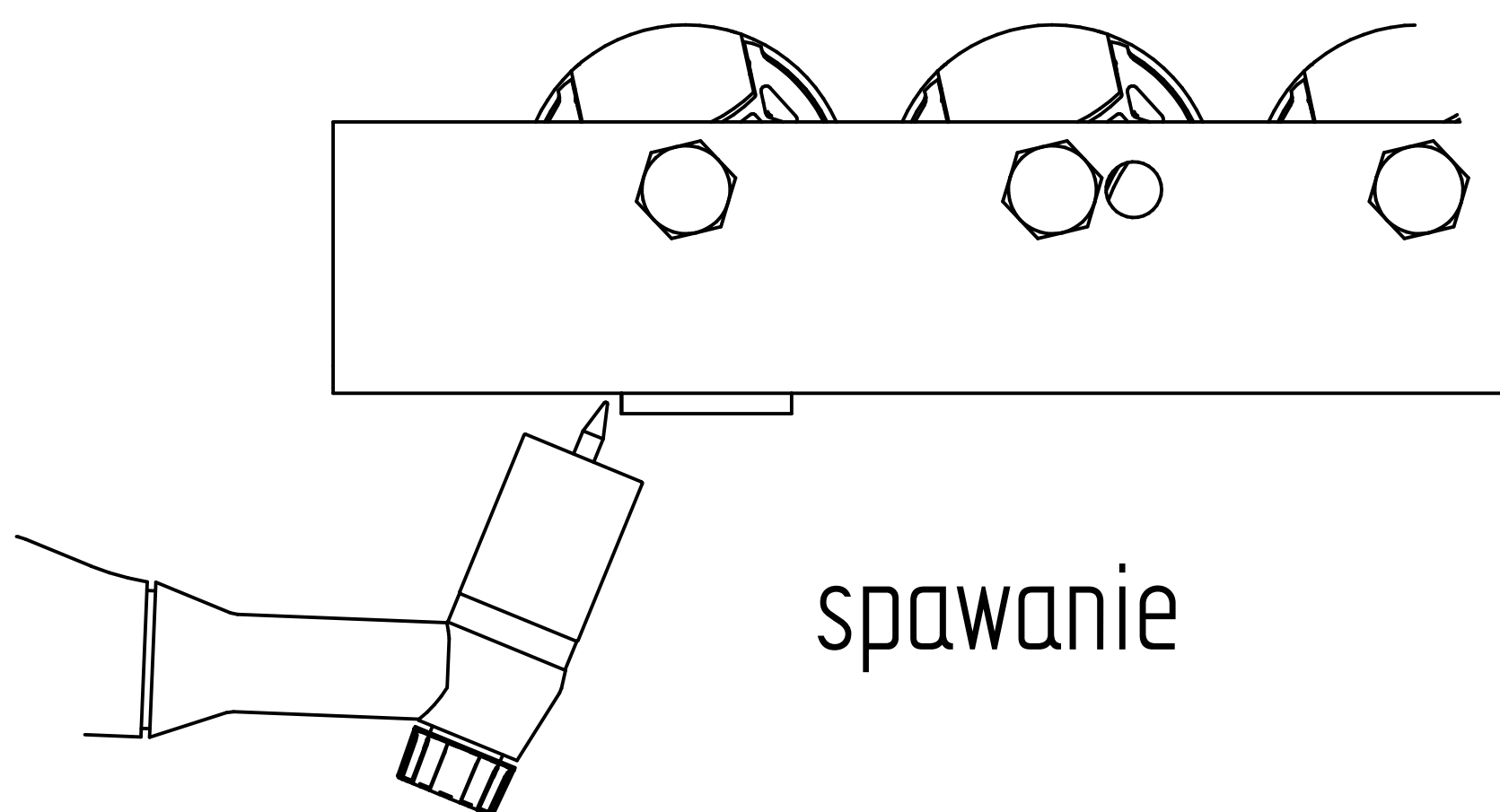

spawanie

Rolki należy schłodzić bezpośrednio po spawaniu