

Listwa T646 – montaż wariant 1

1.

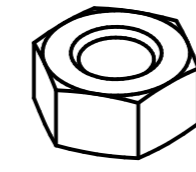

Nakrętka M8 DIN 934

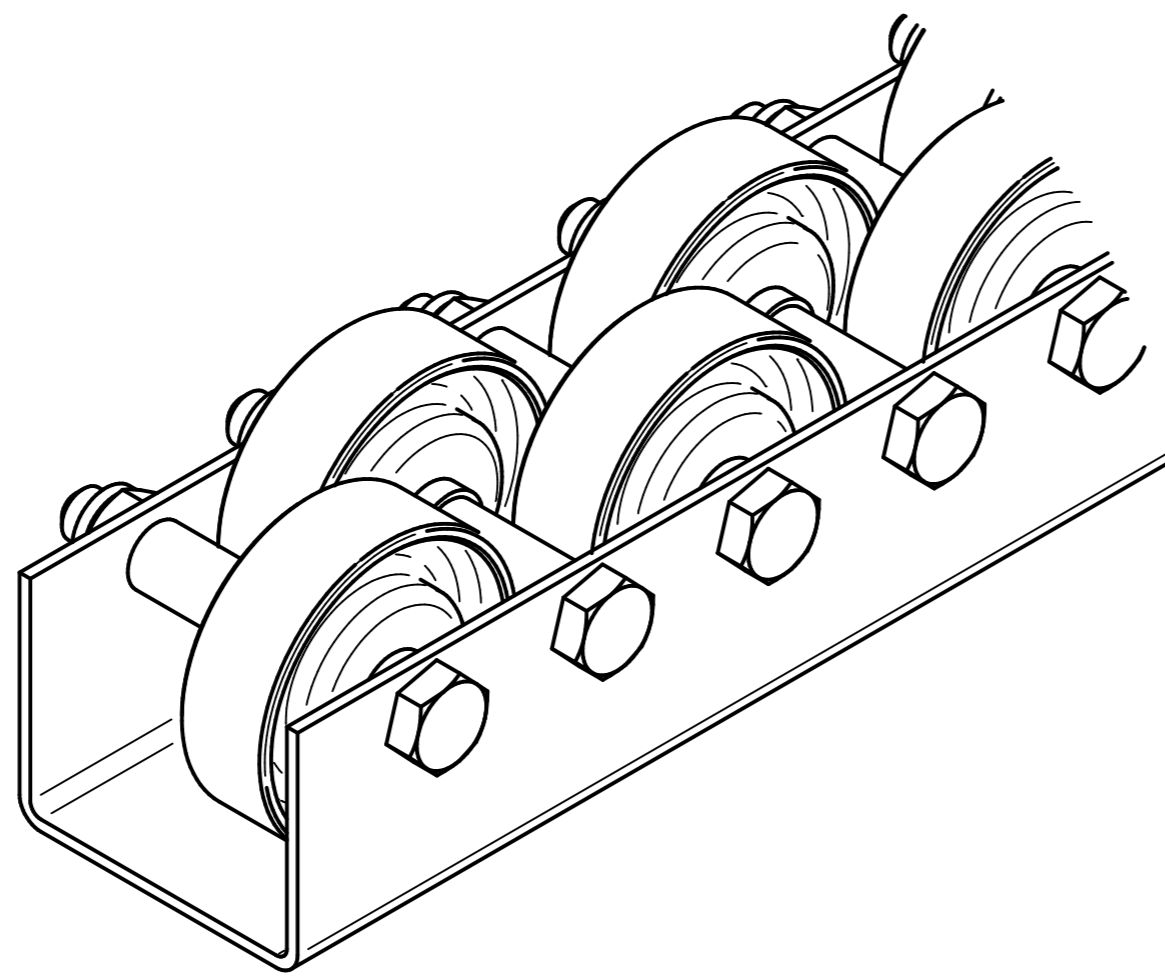
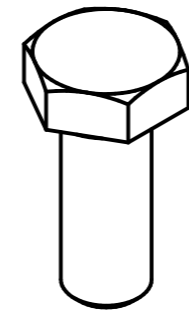

Listwa T646

Śruba DIN 933 M8

2.

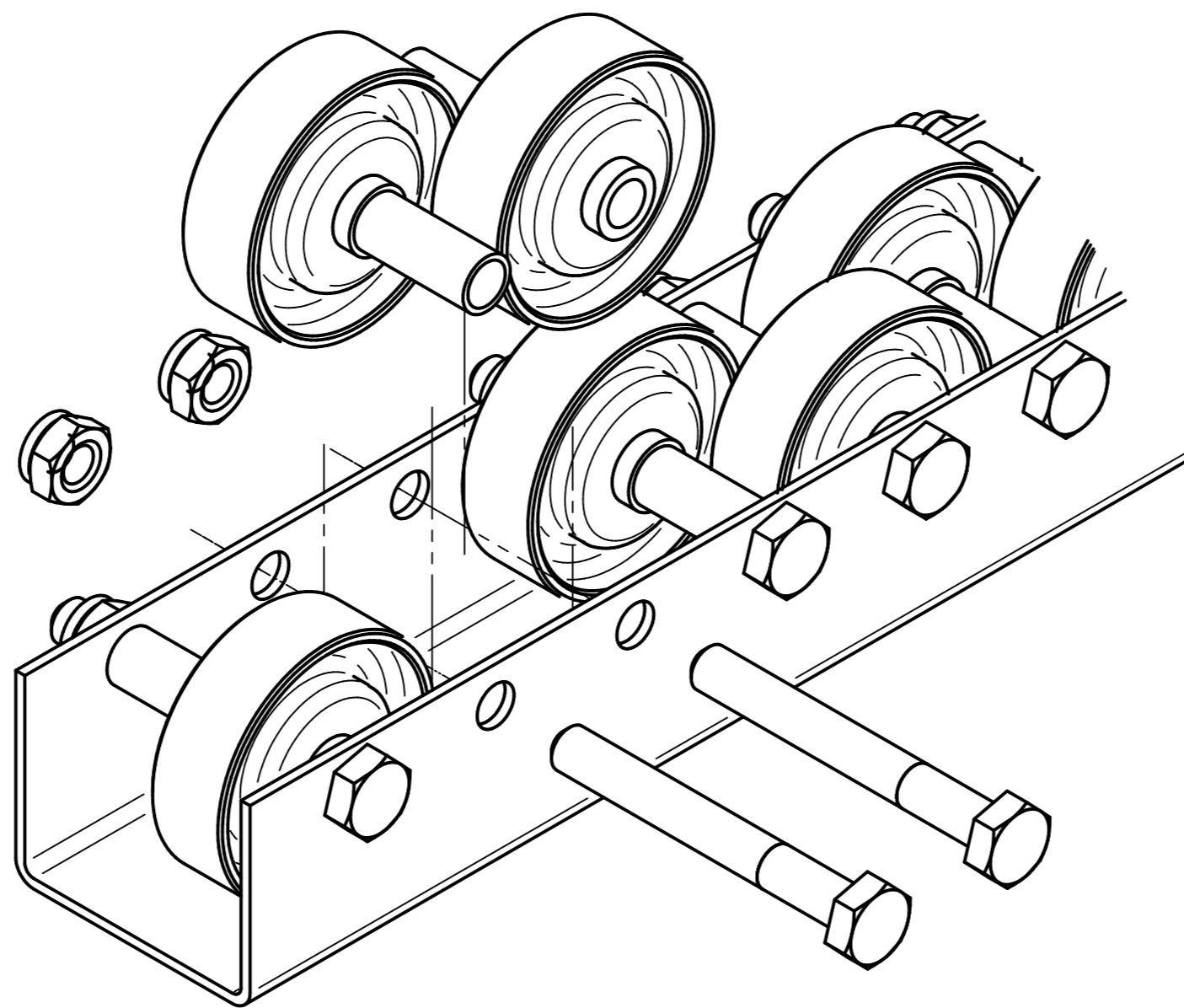

3.

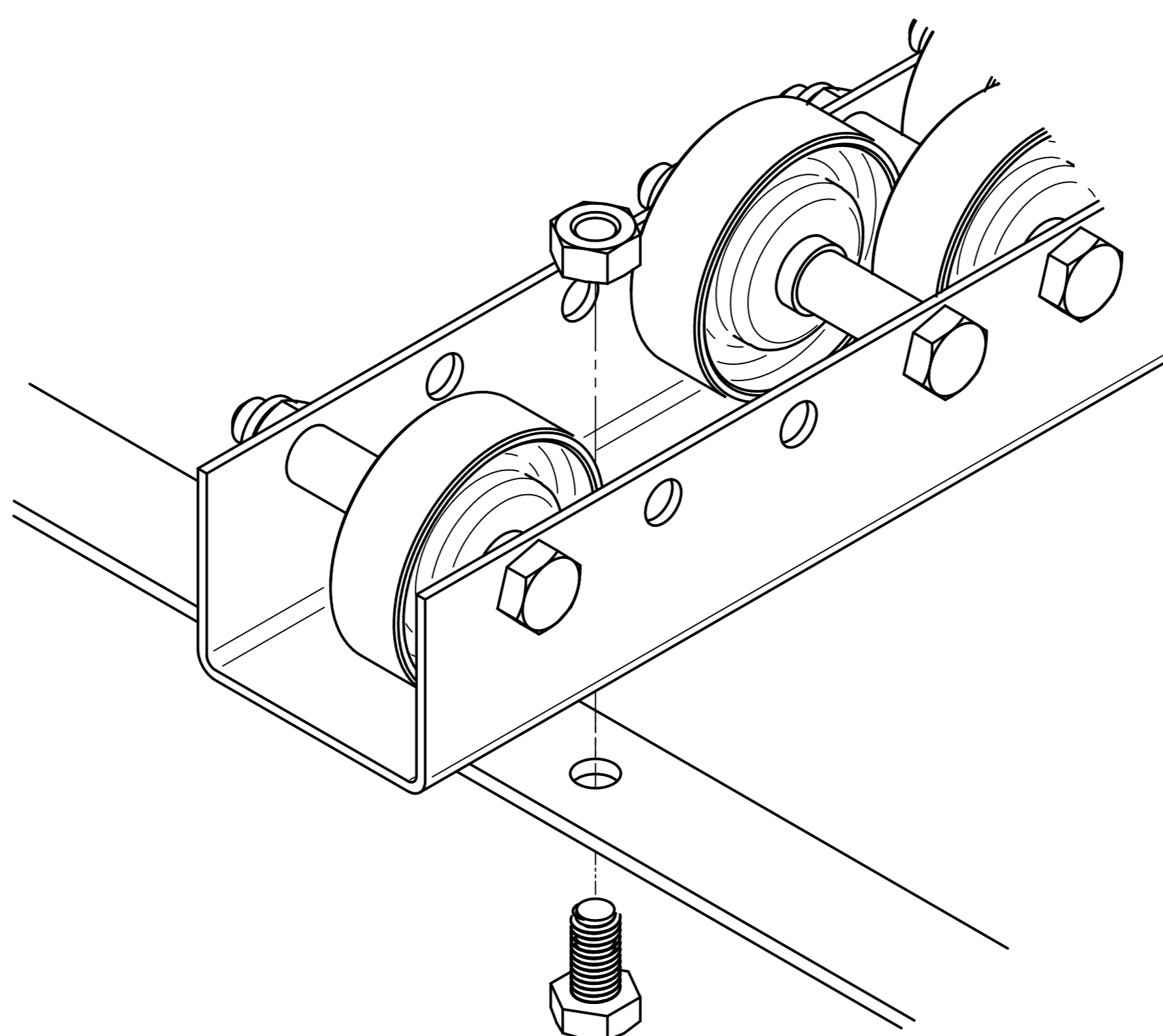

4.

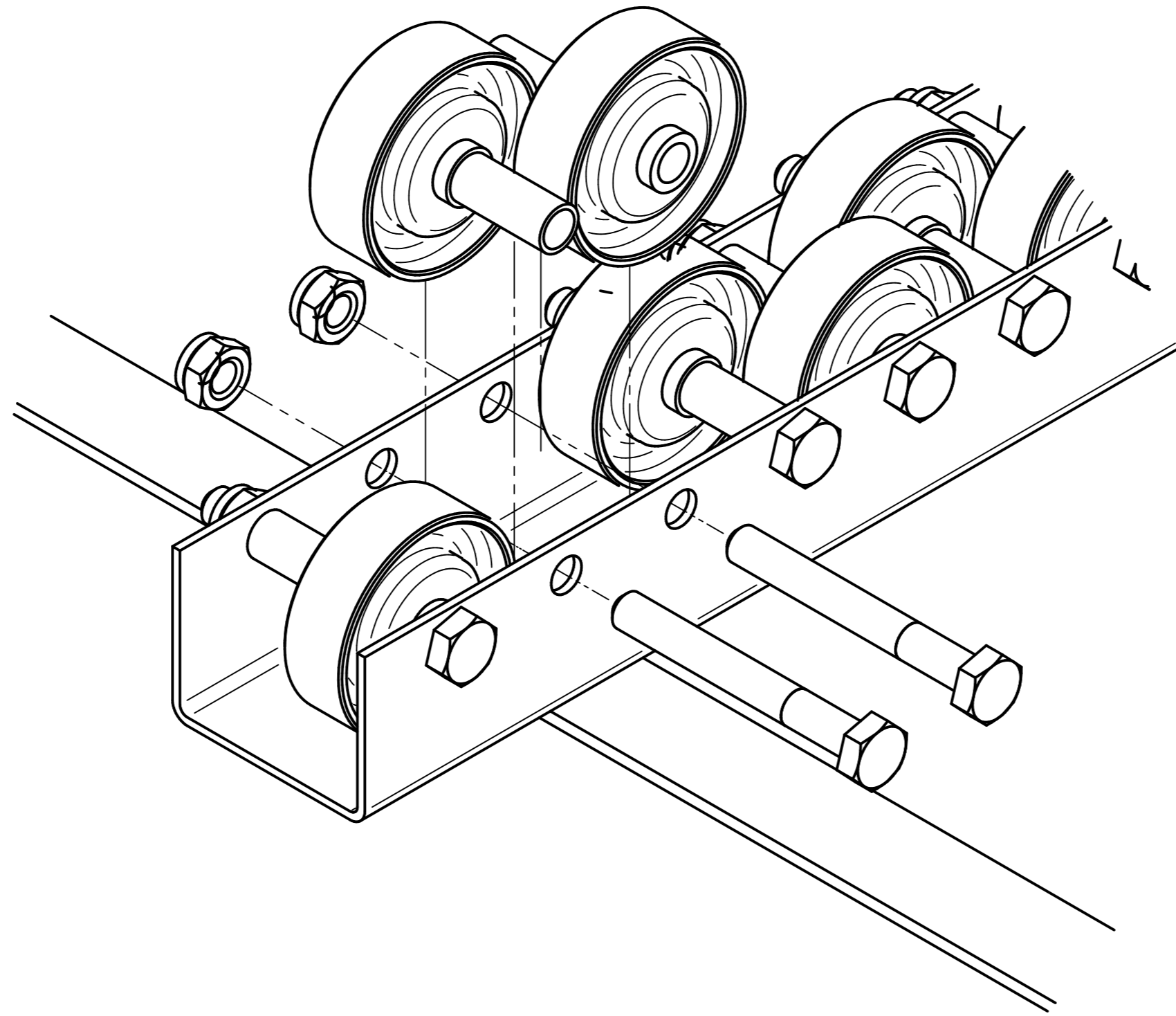

5.

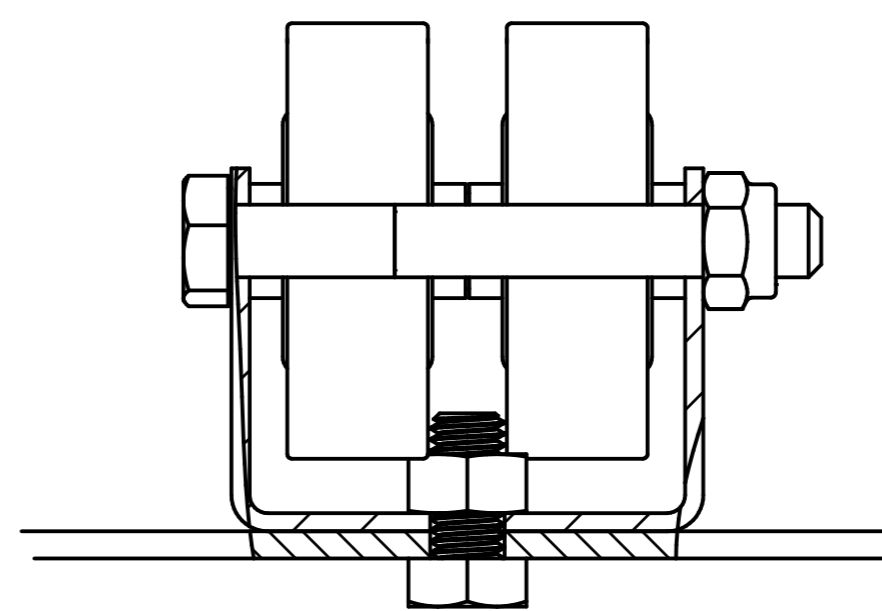
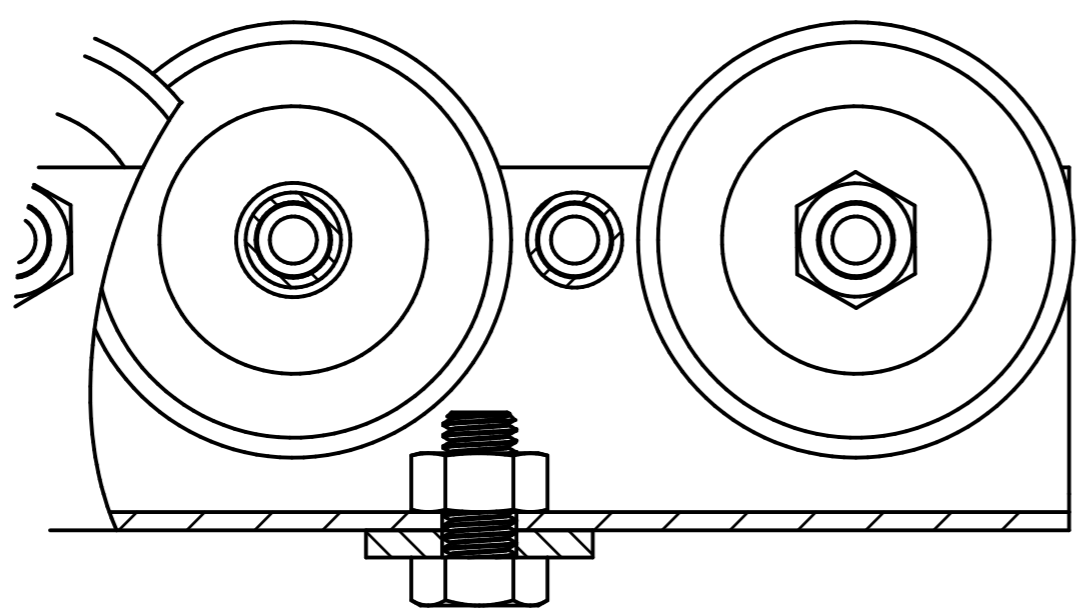
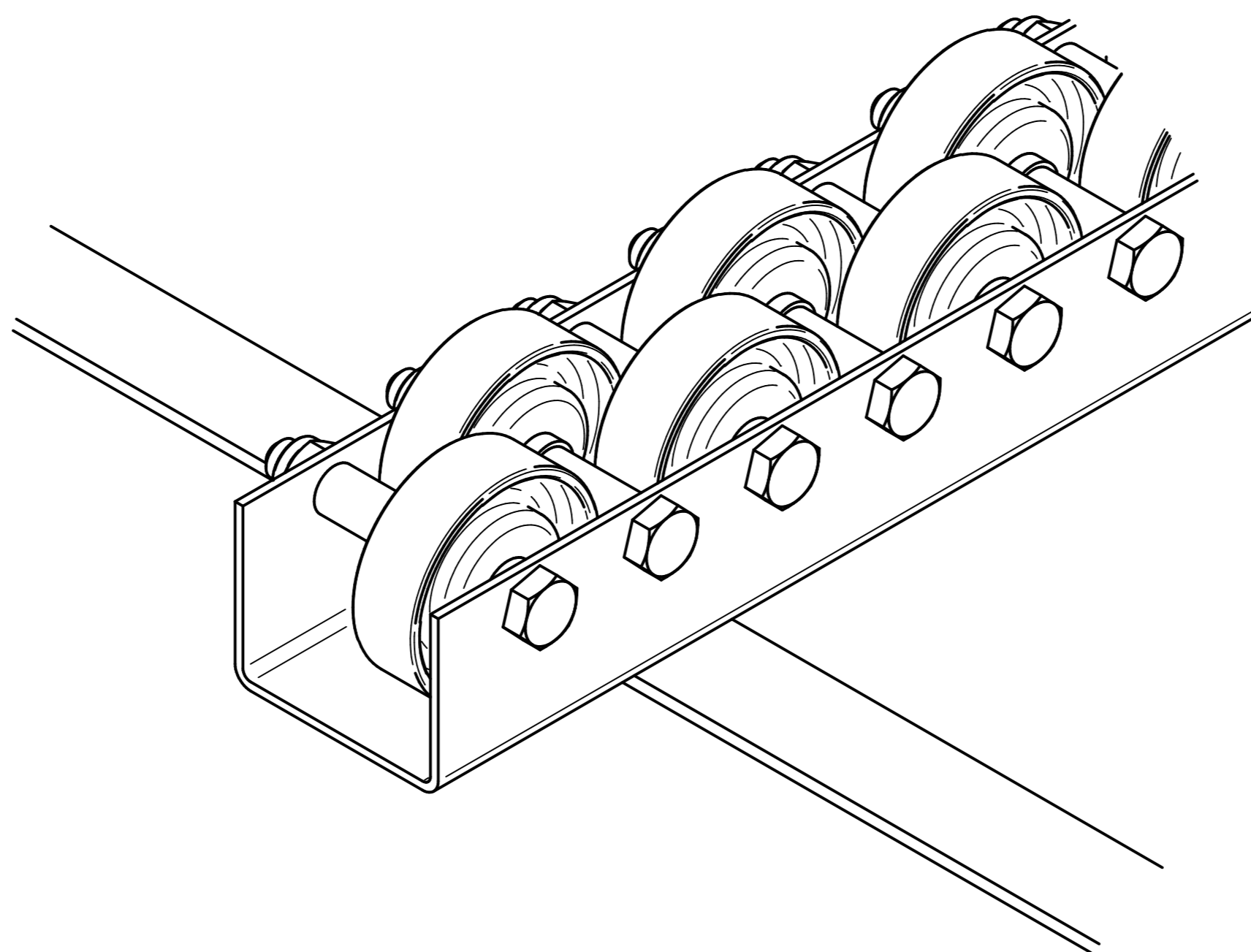

Listwa T646 – montaż wariant 2

1.

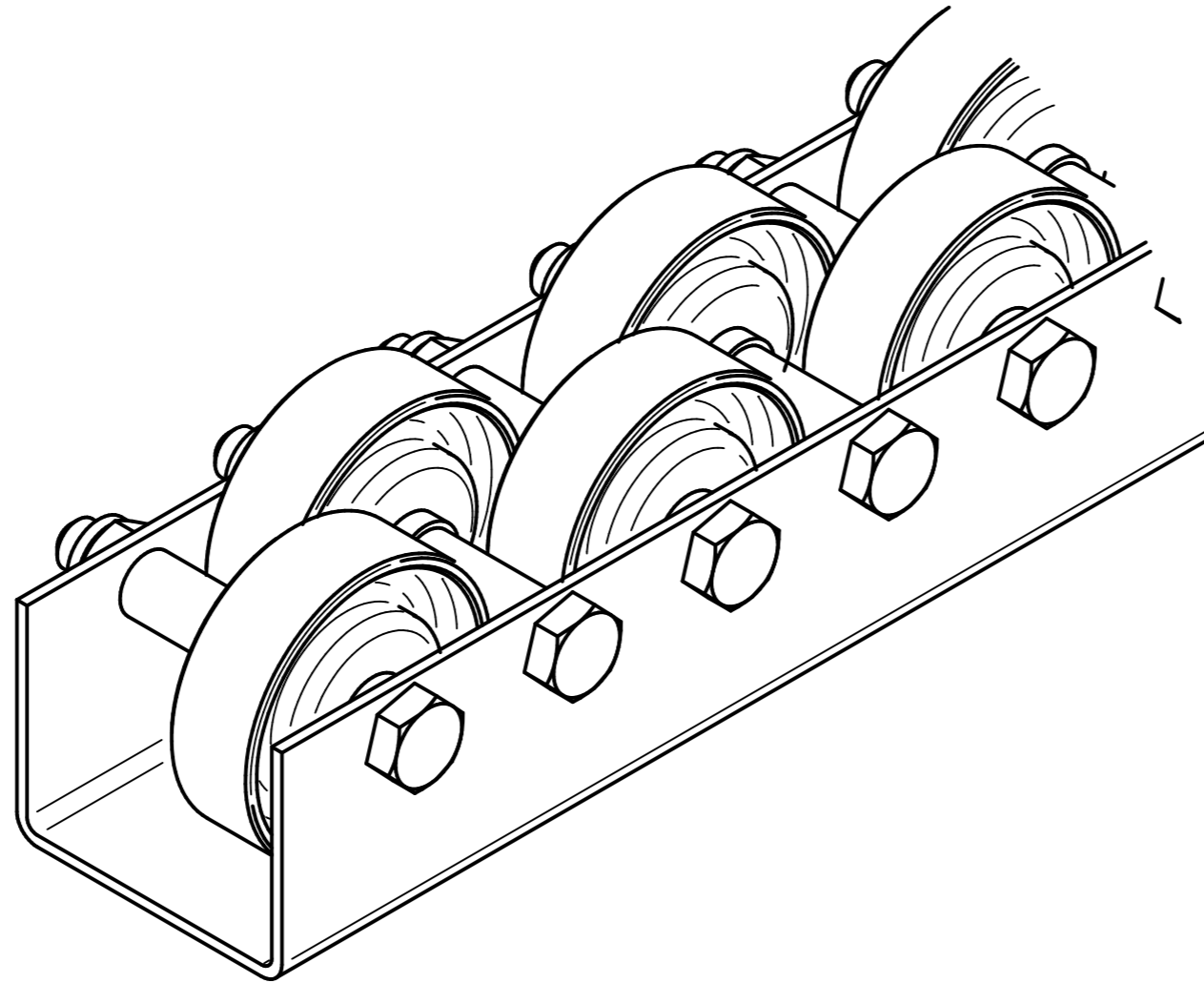

Listwa T646

2.

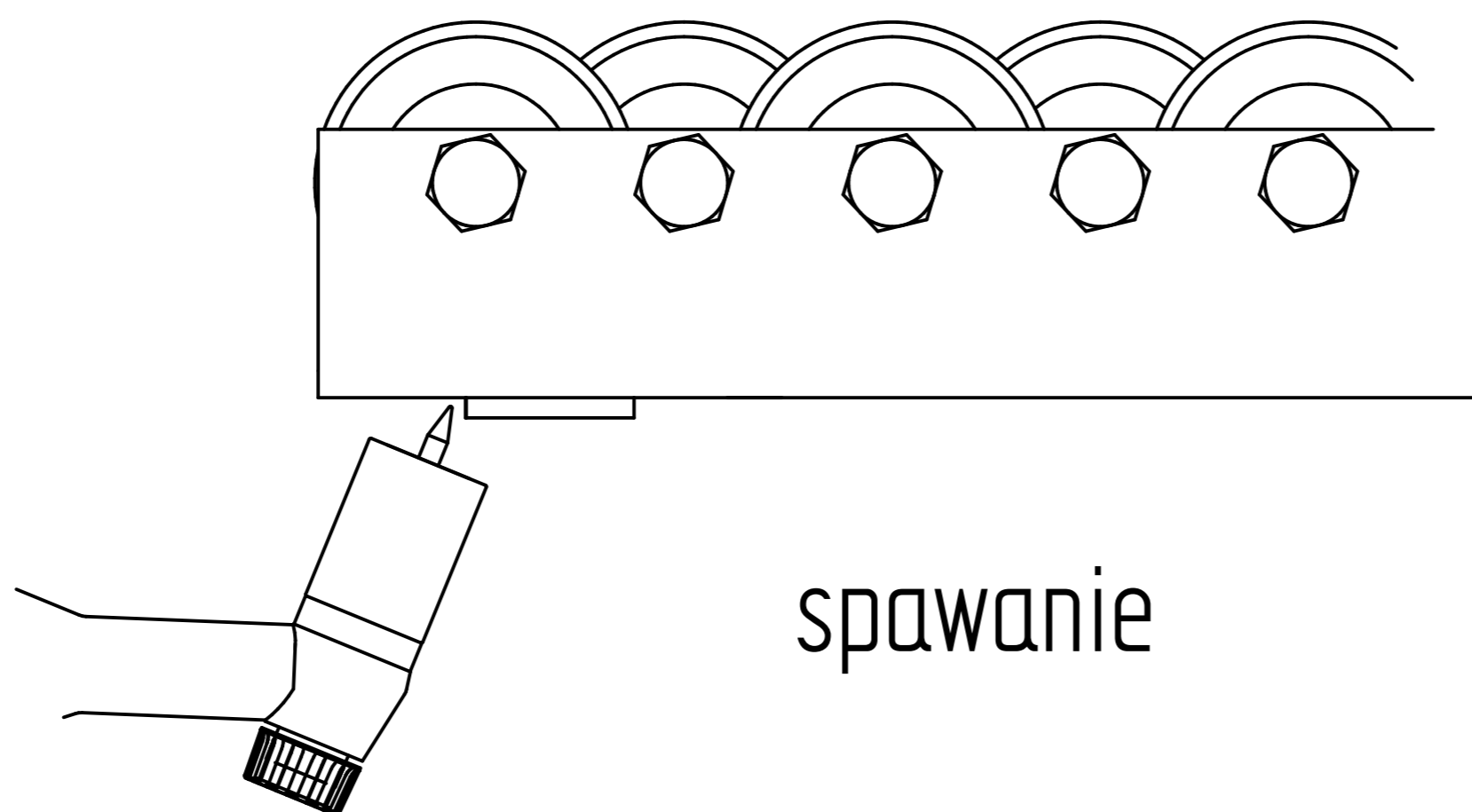

Rolki należy schłodzić bezpośrednio po spawaniu