

Listwa T741 - montaż wariant 1

1.

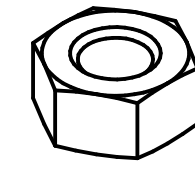

Nakrętka M10 DIN 985

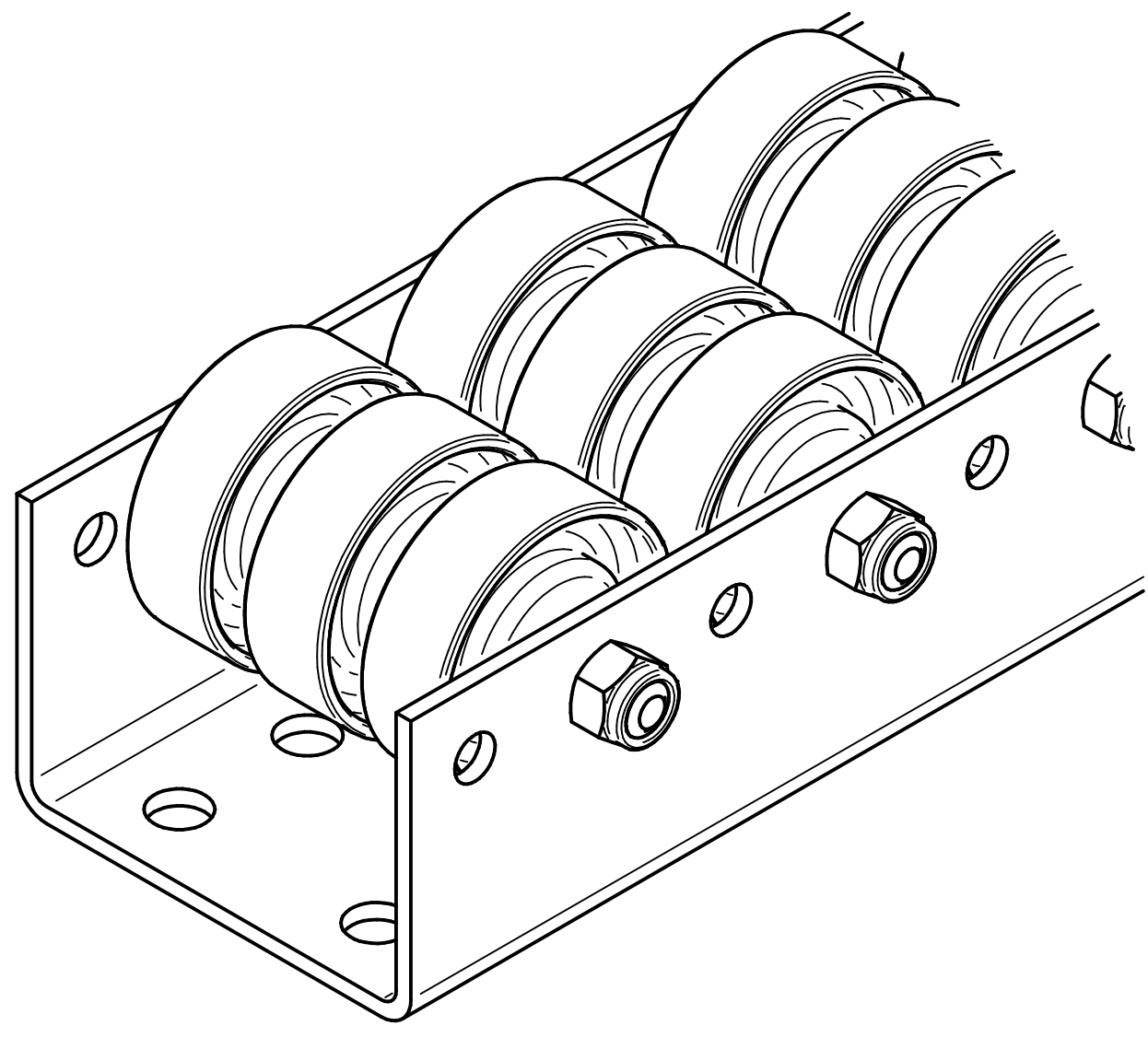
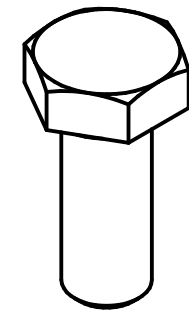

Listwa T741

Śruba DIN 933 M10

2.

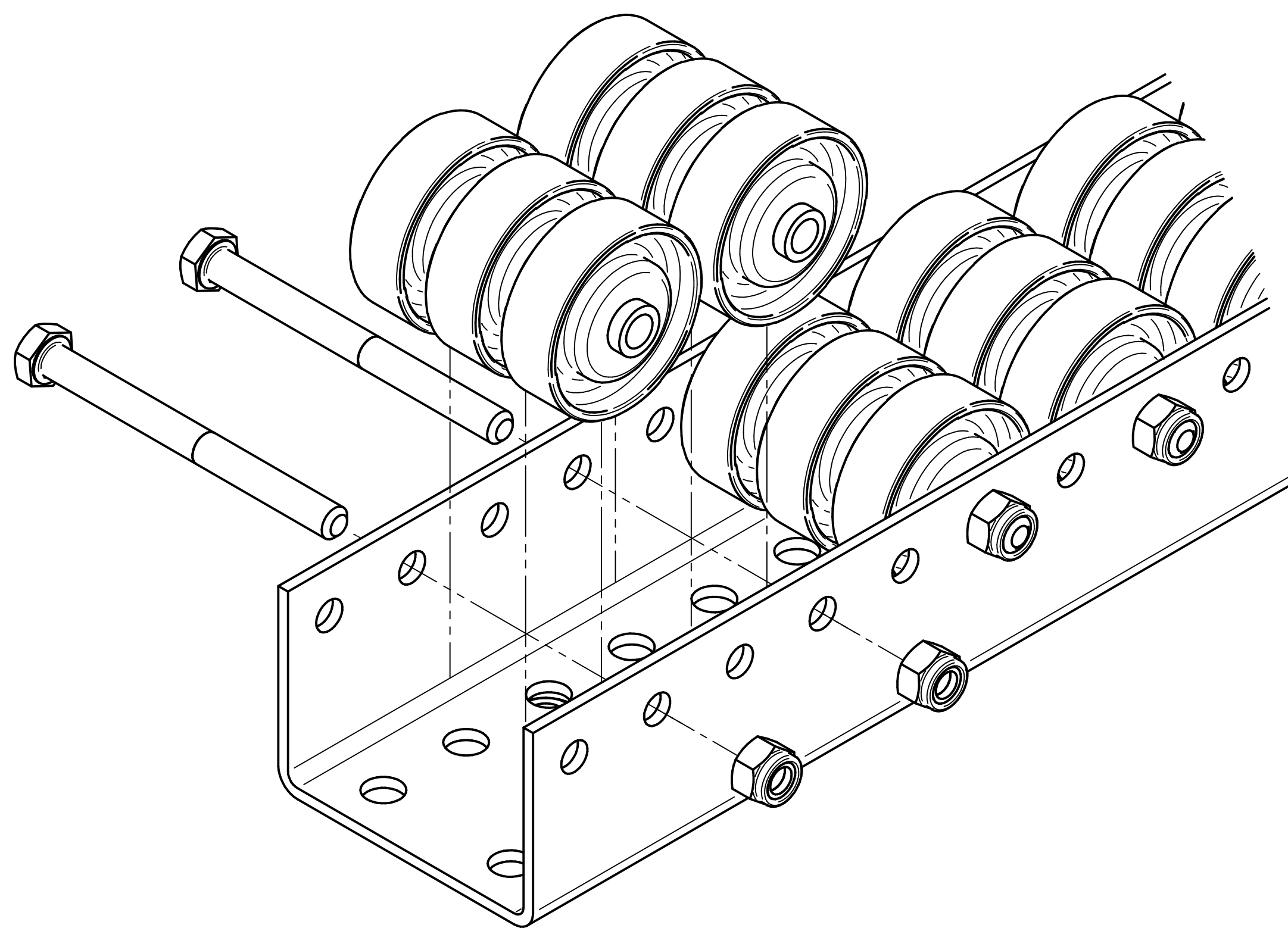

3.

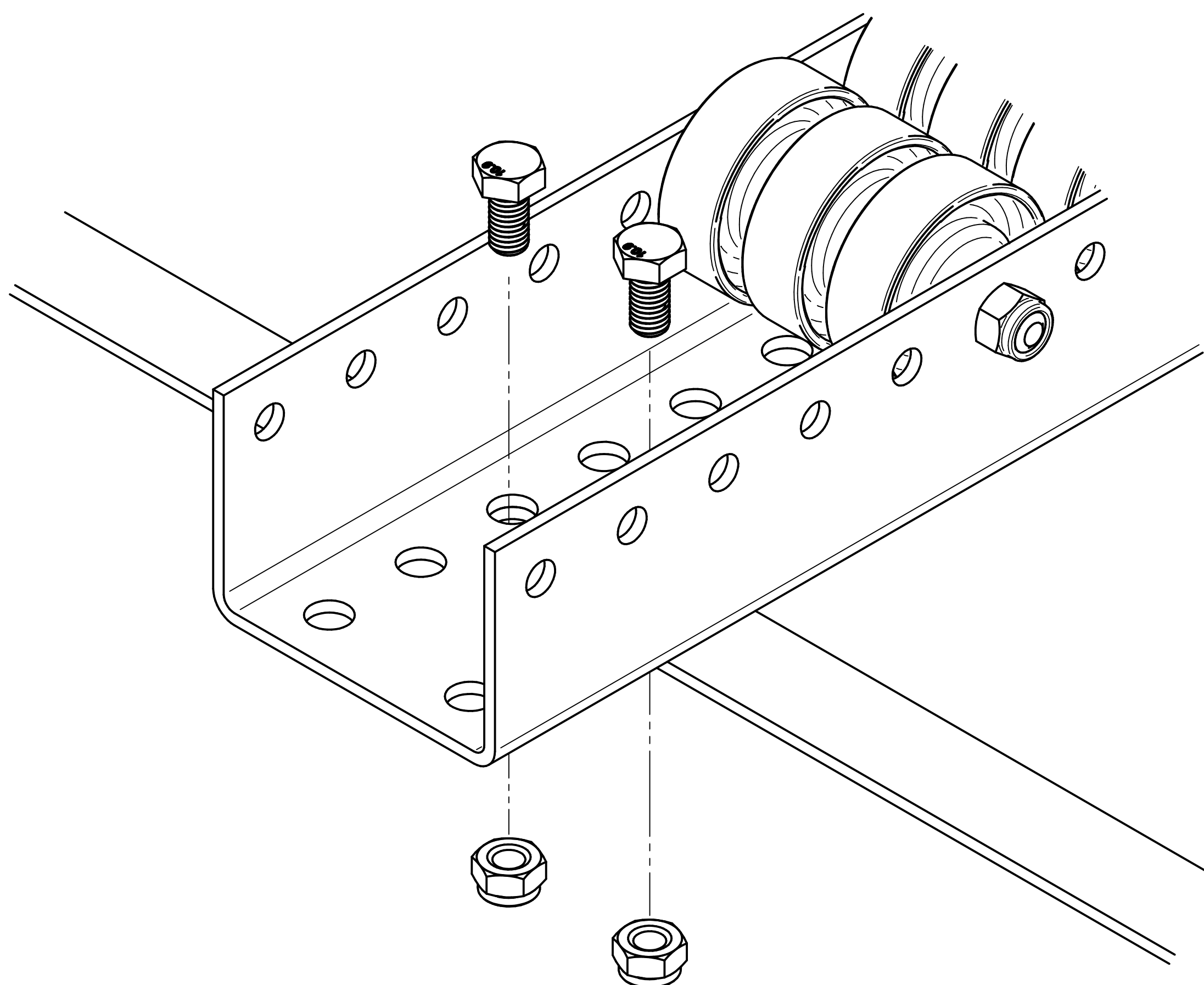

4.

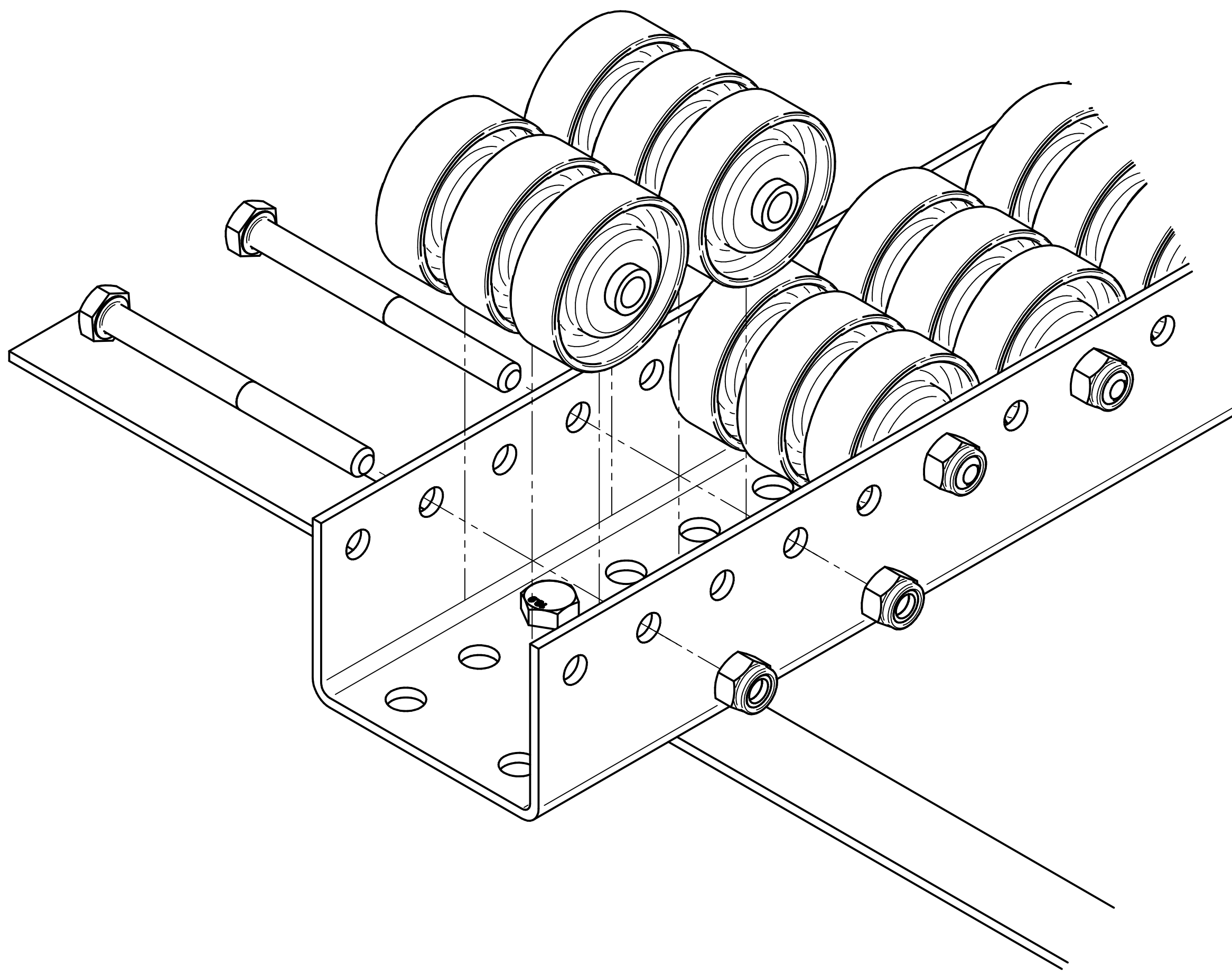

5.

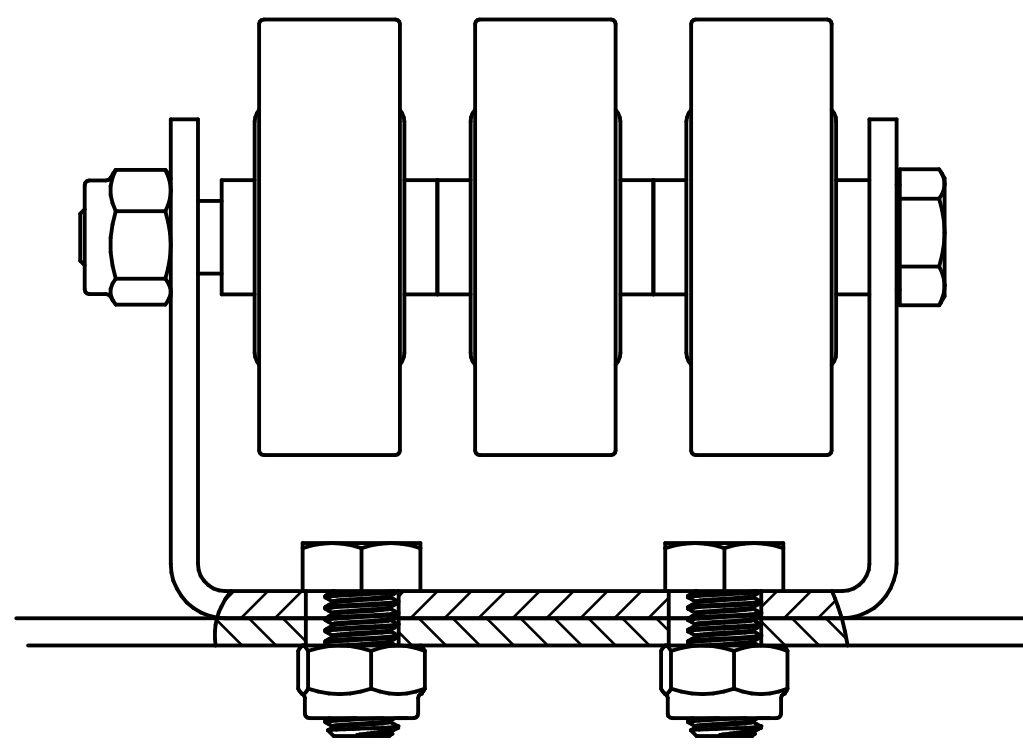
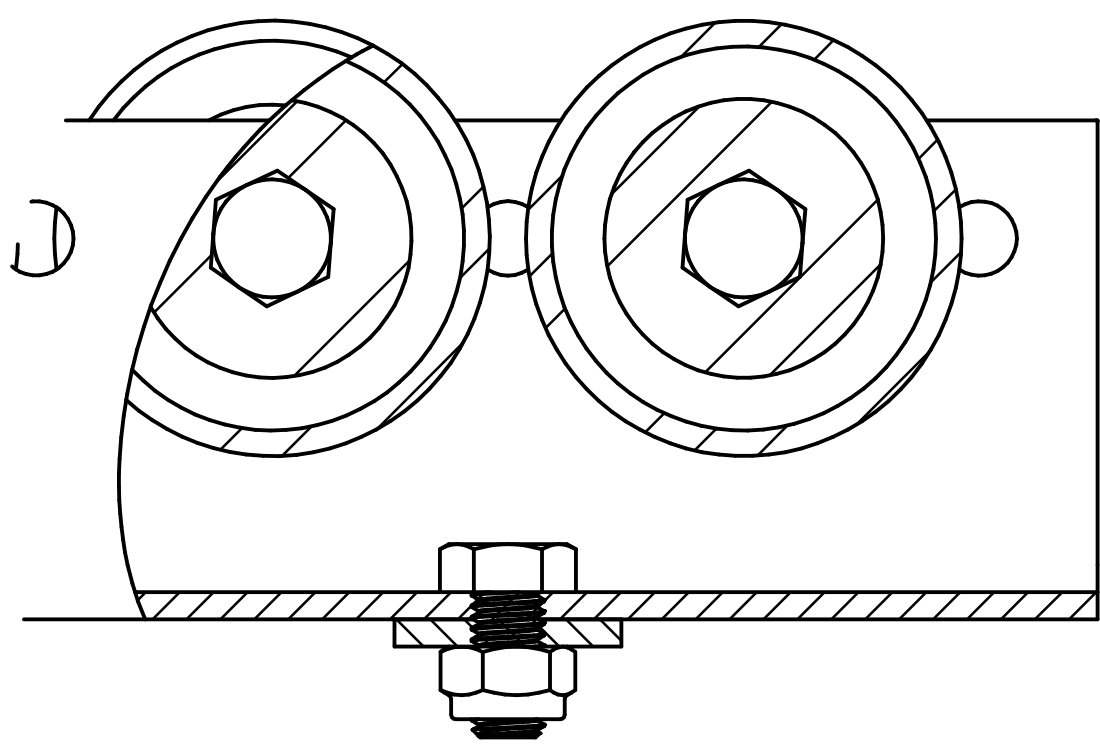
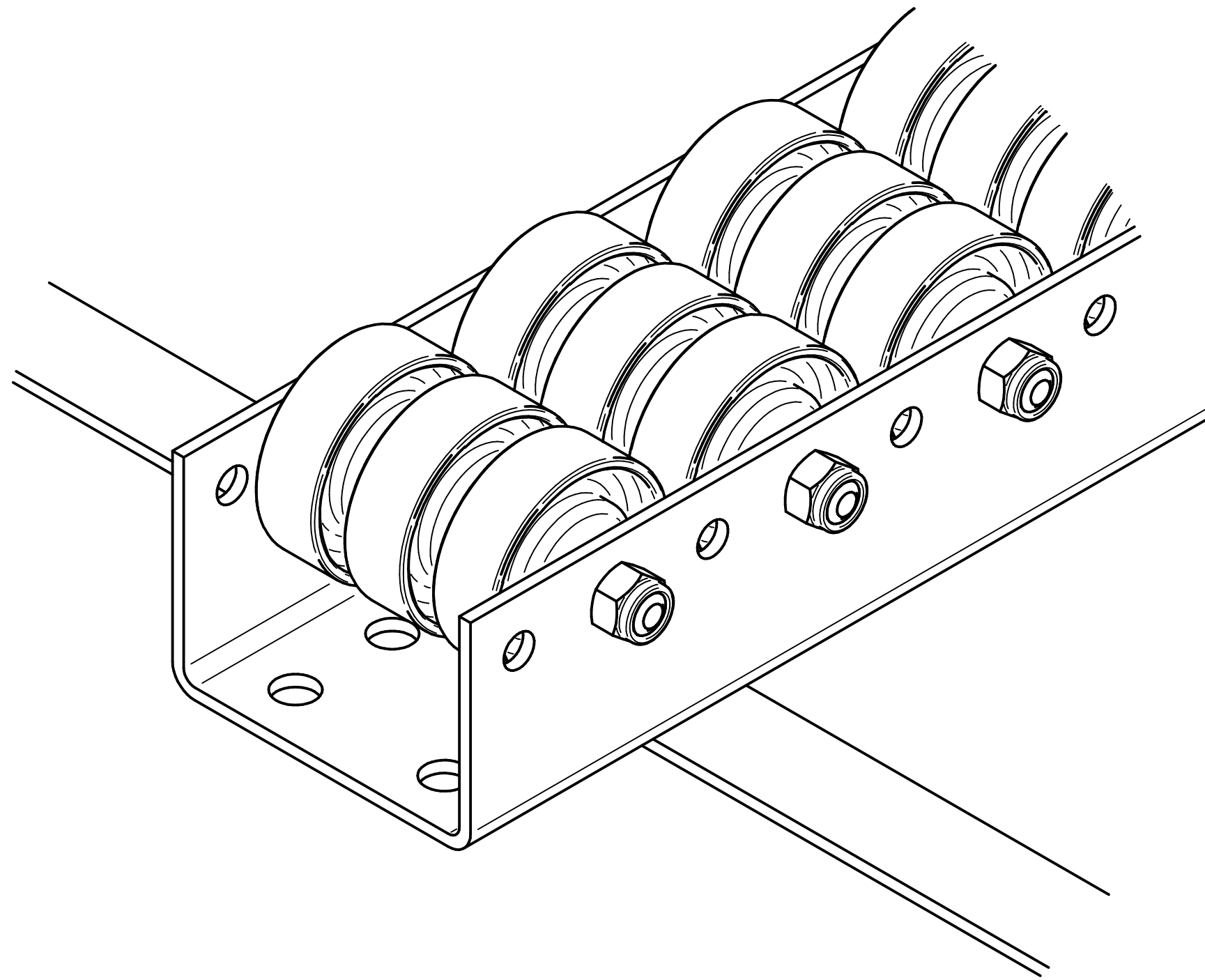

Listwa T741 – montaż wariant 2

1.

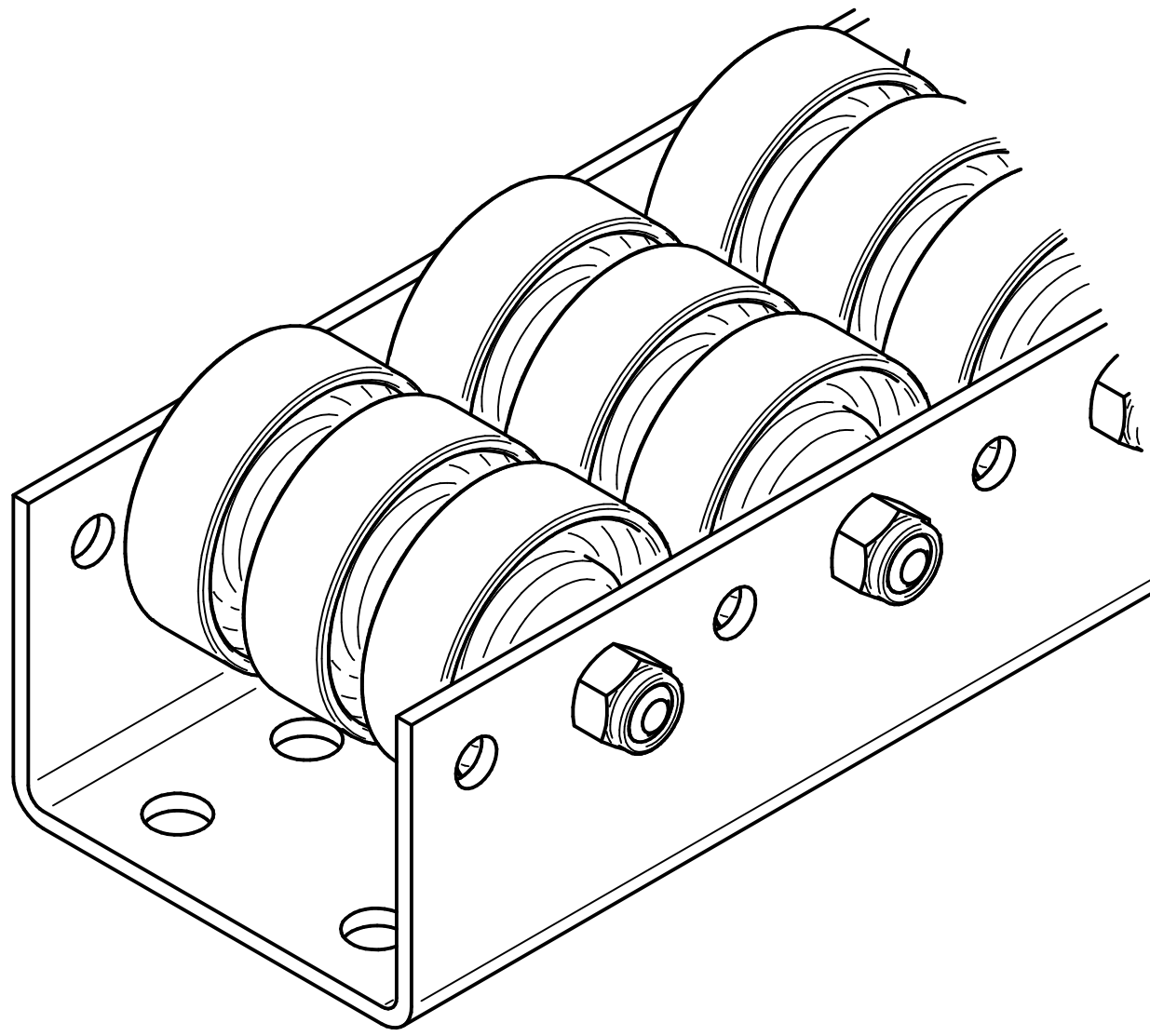

Listwa T741

2.

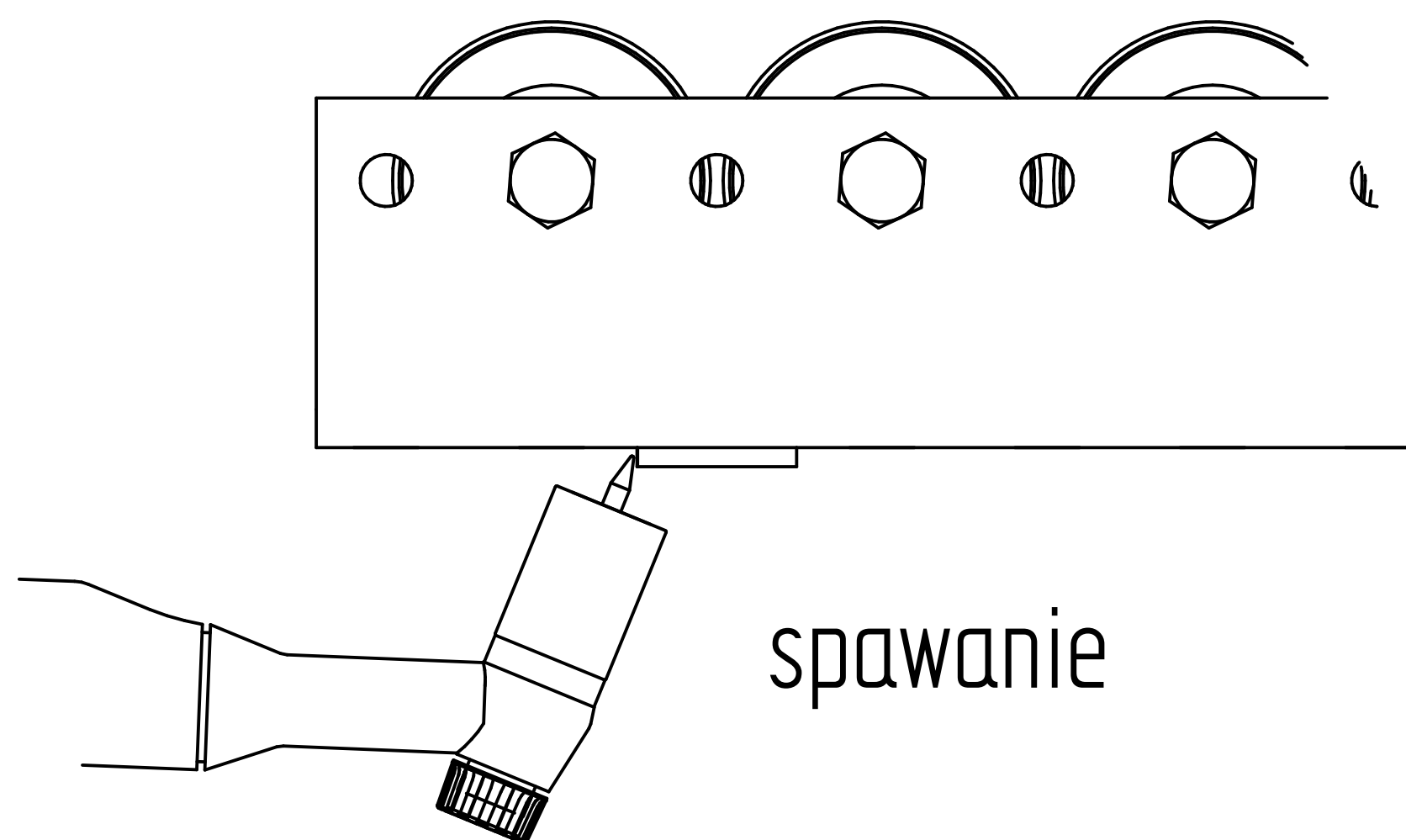

Rolki należy schłodzić bezpośrednio po spawaniu