

KOMPONENTY MASZYN KATALOG

2024

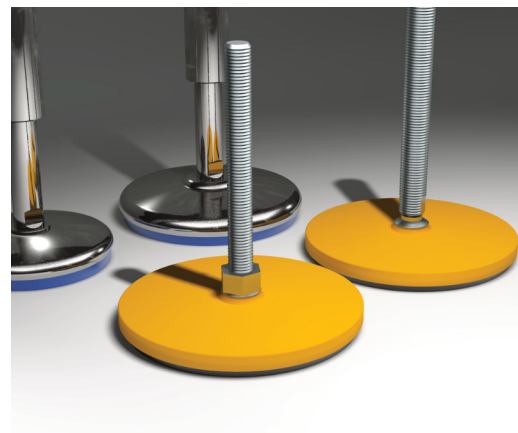
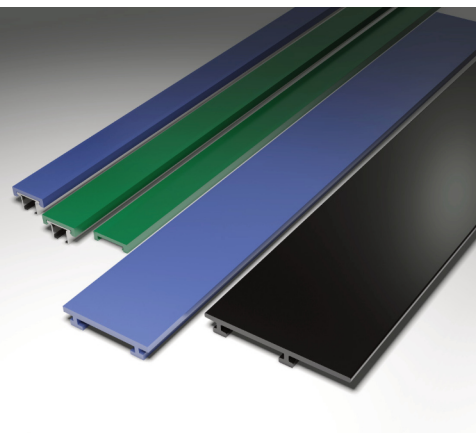
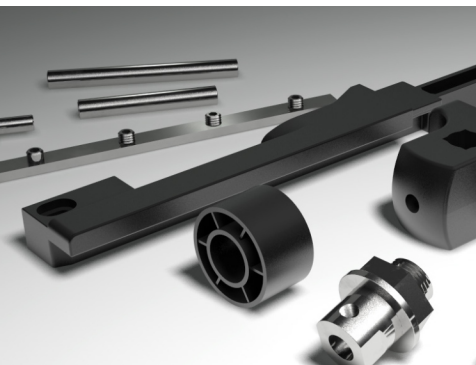

M a d e i n P o l a n d

Podstawy



Głowice



Złącza



Wsporniki

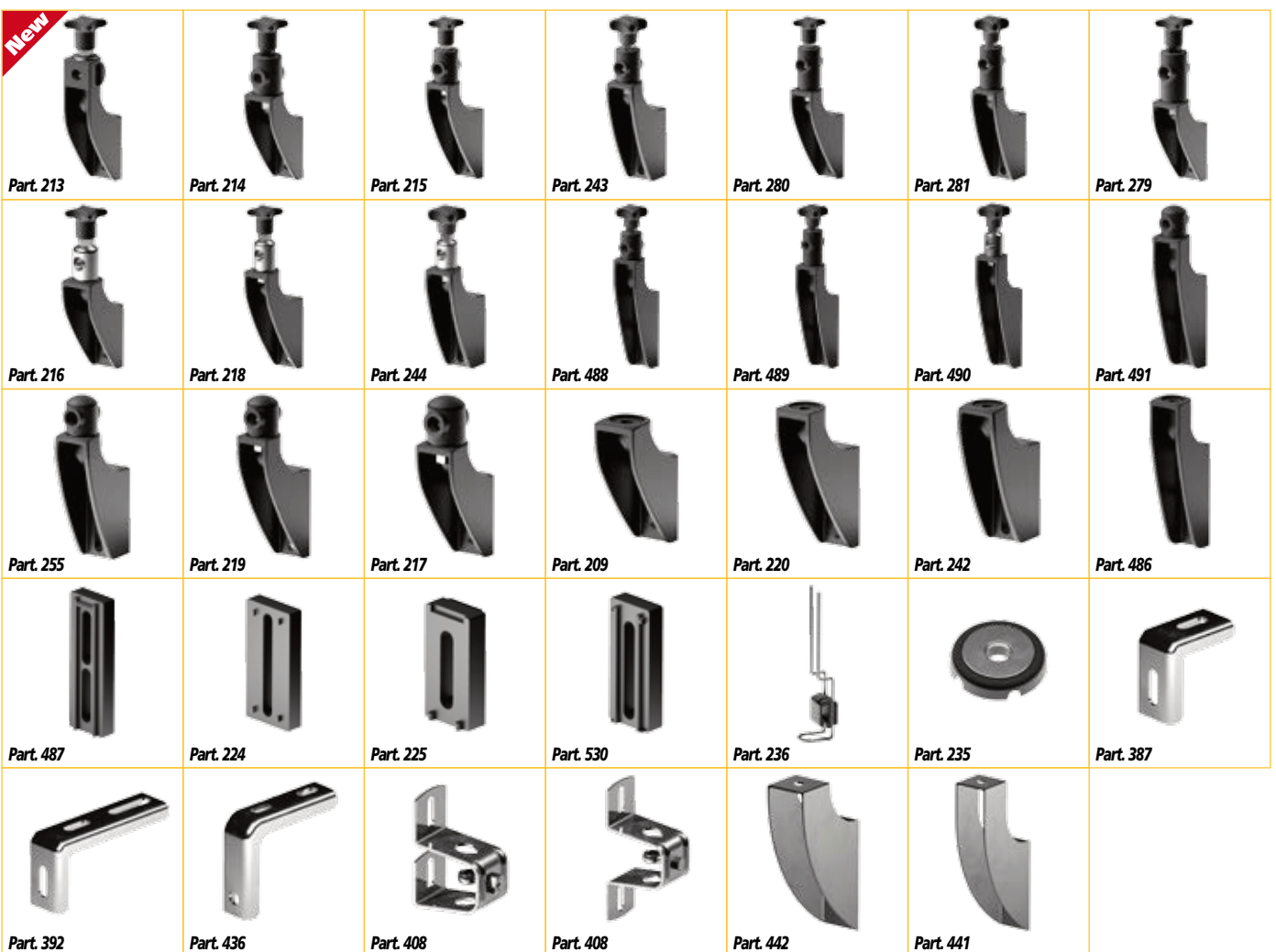

Kotwy mocujące



Głowice



Przekładki



Zaciski



Zaciski

 Part. 537	 Part. 206	 Part. 237	 Part. 240	 Part. 539	 Part. 238	 Part. 324
 Part. 239	 Part. 241	 Part. 297	 Part. 312	 Part. 435	 Part. 333	

Prowadniki

 Part. 428	 Part. 267	 Part. 359
--	--	---

Zespoły napinaczy

 Part. 277	 Part. 278
--	--

Rolki wsporcze nawrotu

 Part. 379	 Part. 380	 Part. 270	 Part. 271	 Part. 273	 Part. 538	 Part. 286
 Part. 287	 Part. 274	 Part. 275	 Part. 272	 Part. 520	 Part. 302	 Part. 250
 Part. 251	 Part. 296	 Part. 252	 Part. 253	 Part. 249	 Part. 245	 Part. 399
 Part. 293	 Part. 525	 Part. 276	 Part. 254	 Part. 524	 Part. 282	

Odsyłanie łańcucha



Zespoły walcowe



Zaślepki



Zawiasy

























































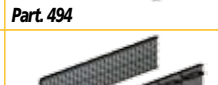





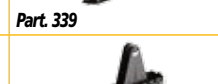

























Pierścienie oporowe



Moduły i rolki





Prowadnice produktu i akcesoria

 Part. 306	 Part. 307	 Part. 308	 Part. 319	 Part. 468	 Part. 474
 Part. 475	 Part. 476	 Part. 325	 Part. 326	 Part. 327	 Part. 328
 Part. 467	 Part. 477	 Part. 478	 Part. 479	 Part. 355	 Part. 356
 Part. 357	 Part. 358	 Part. 464	 Part. 480	 Part. 482	 Part. 466
 Part. 465	 Part. 320	 Part. 321	 Part. 322	 Part. 323	 Part. 329
 Part. 463	 Part. 528	 Part. 511	 Part. 318	 Part. 437	 Part. 522
 Part. 415	 Part. 481	 Part. 493	 Part. 494	 Part. 340	 Part. 341
 Part. 342	 Part. 343	 Part. 345	 Part. 423	 Part. 339	 Part. 422
 Part. 344	 Part. 421	 Part. 448	 Part. 451	 Part. 449	 Part. 452
 Part. 450	 Part. 453	 Part. 502	 Part. 501	 Part. 501	 Part. 501
 Part. 501	 Part. 388	 Part. 393	 Part. 394	 Part. 395	 Part. 500
 Part. 544	 Part. 545	 Part. 330	 Part. 375	 Part. 426	 Part. 425
 Part. 518	 Part. 536	 Part. 515	 Part. 534	 Part. 373	 Part. 354
 Part. 418	 Part. 419	 Part. 420	 Part. 353	 Part. 469	 Part. 514
 Part. 485	 Part. 438	 Part. 369	 Part. 370	 Part. 371	

Prowadnice łańcucha i akcesoria

 Part. 446	 Part. 381	 Part. 384	 Part. 385	 Part. 513	 Part. 512
 Part. 517	 Part. 377	 Part. 444	 Part. 389	 Part. 519	 Part. 390
 Part. 391	 Part. 461	 Part. 492	 Part. 496	 Part. 495	 Part. 497
 Part. 471	 Part. 498	 Part. 499	 Part. 361	 Part. 362	 Part. 363
 Part. 364	 Part. 365	 Part. 366	 Part. 367	 Part. 368	

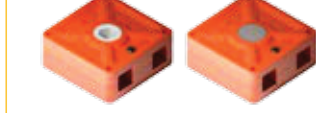
Elementy do zmiany formatu

 Part. 429	 Part. 316	 Part. 299	 Part. 331
 Part. 352	 Part. 462	 Part. 374	

Kontrola linii



Pełna wersja katalogu: [LINK](#)

CONSTRUKTOR[™]
www.construktor.com

&



OFICJALNY PARTNER FIRMY:

teCom
Technology Components

TECOM S.r.l.

Via A.M. Ampère, 43 - 42017 Novellara(RE) - Italy

Tel.: (+39) 0522-651203 Tel.: (+39) 0522-651369

*** b: <https://www.tecomsrl.it> e-mail: info@tecomsrl.it